

Installation and configuration manual

With Deye

Pytes Lithium Battery

E-BOX series

With Deye Inverter

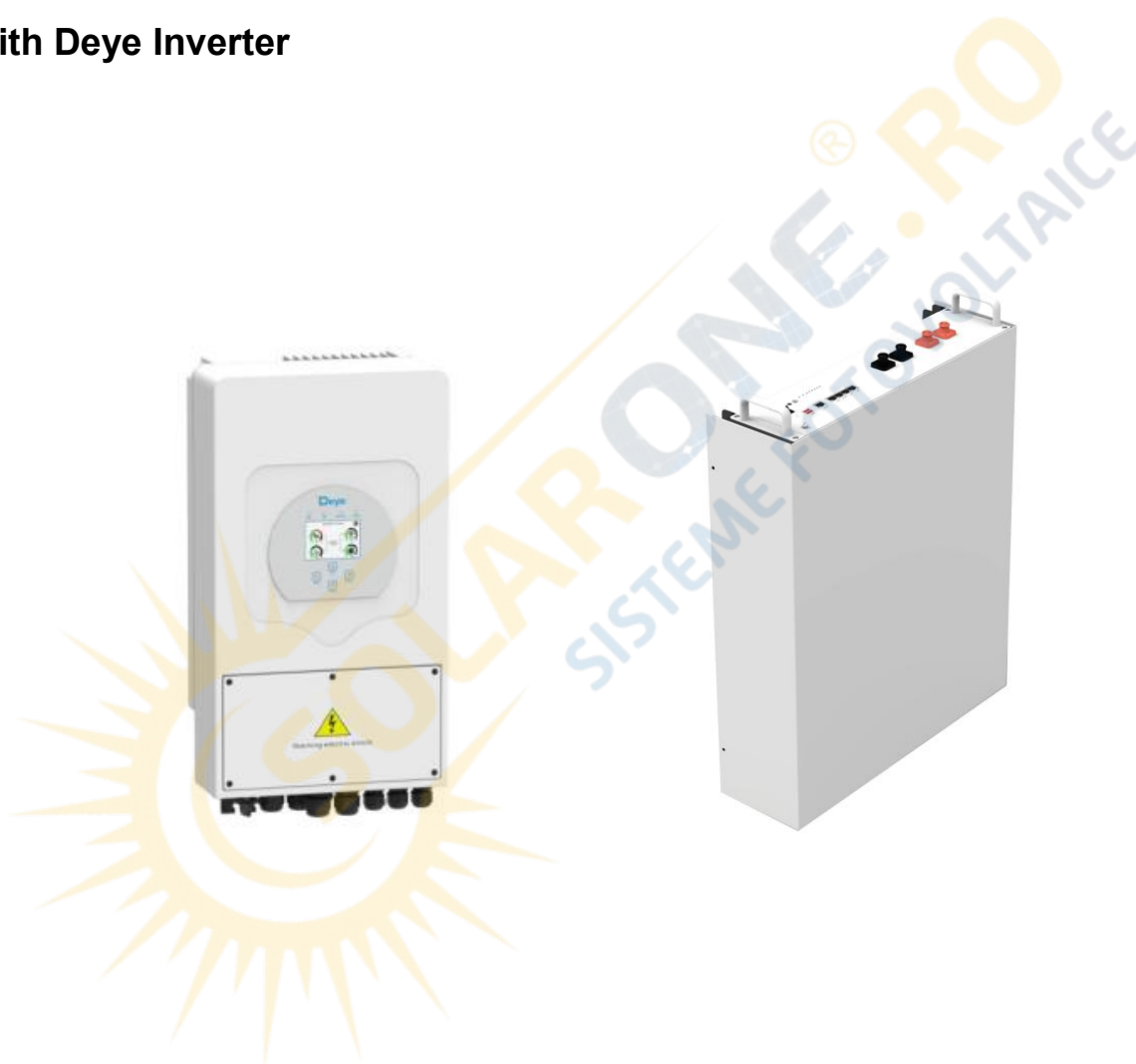

CONTENTS

BOM LIST	3
1. Power Cable Connection	5
Step.1	6
Step.2	6
Step.3	6
2. Communication Cable Connection	7
3. Set The DIP Switch	7
4. Start up the system	8
5.Change the battery setting of the inverter	8
Step1	8
Step2	9
Step3	9
6.Check the battery soc	10
Step.1	10
Step.2	10
7.System monitoring	12

BOM LIST

Before installation, you should prepare following items.

Item	Remarks	Quantity
Power Cable (DC)	<input type="checkbox"/> Conductor cross-section: 50 mm ² to 95 mm ² <input type="checkbox"/> Cable diameters: 14 mm to 25 mm <input type="checkbox"/> Only copper cables may be used. <input type="checkbox"/> The DC cables must be sized for the maximum battery voltage and the maximum battery current (see battery manufacturer documentation).	Depends on the number of batteries and the connection method
CAN Cable	CAN communication Terminal (RJ45 port) follow CAN protocol, to output batteries information	1
Battery	48100R / 48100C / 4850	Depends on the number of batteries and the connection method
Inverter	Deye	1

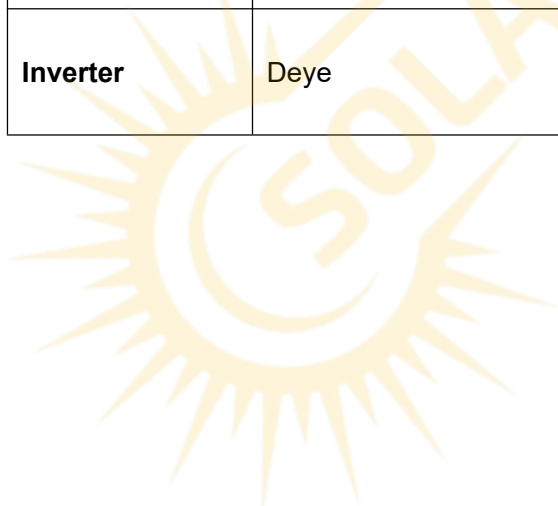

Definition of RJ45 Port Pin for BMS is as follow.



RS485 port definition

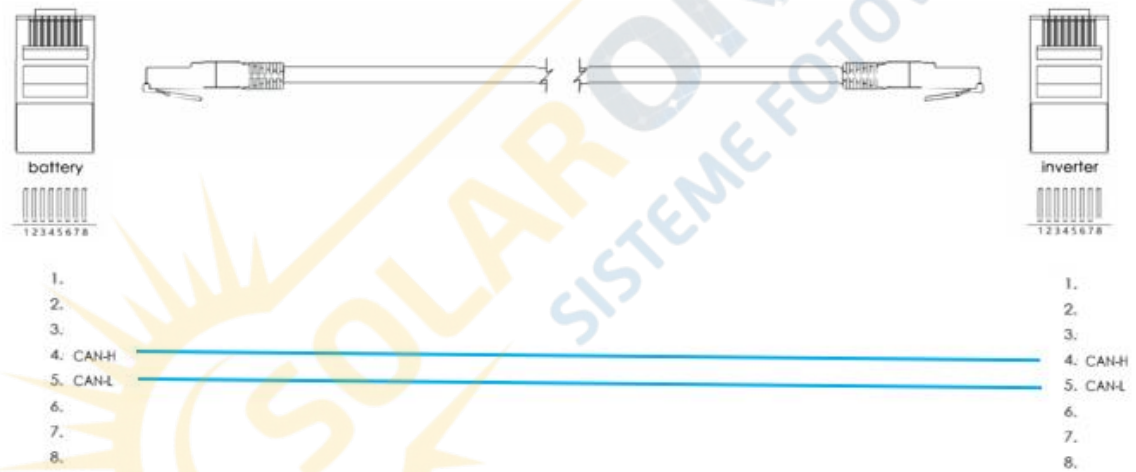

CAN port definition

HOW TO INSATLL

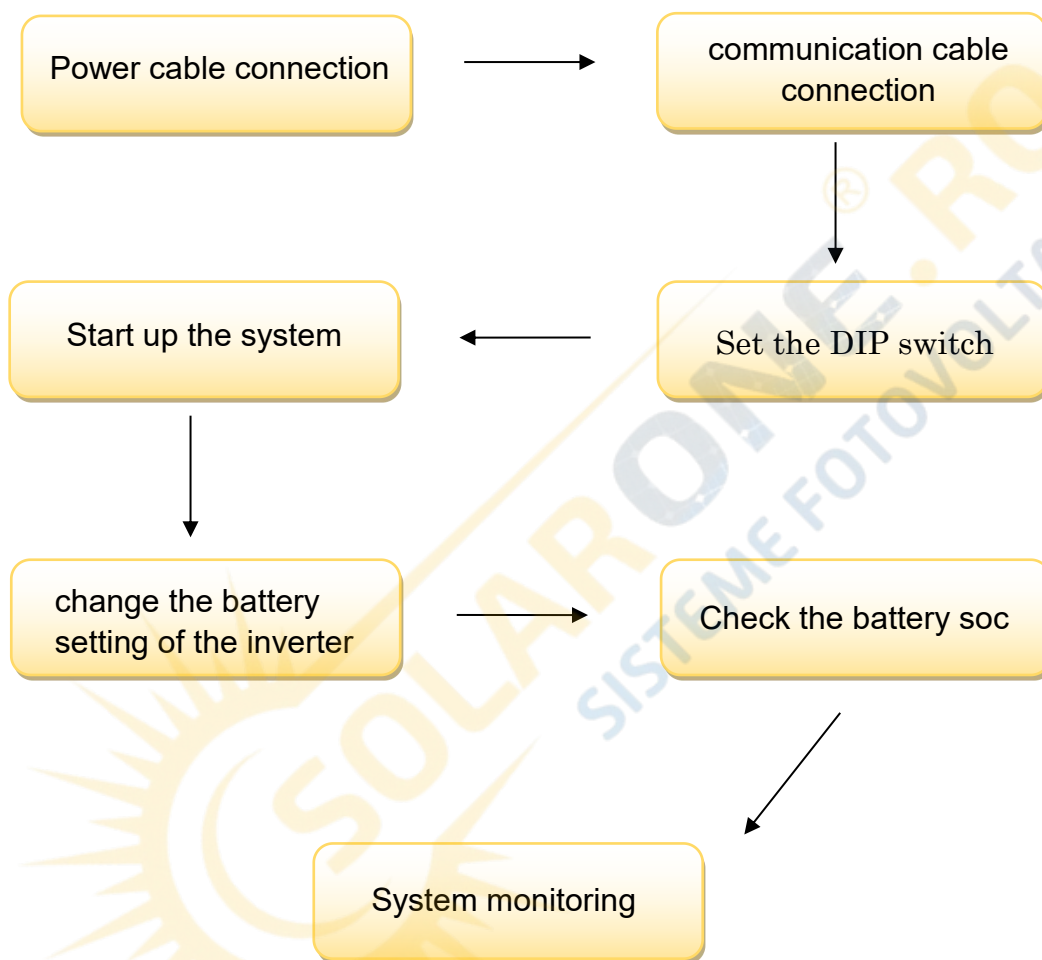

CAUTION: If you want to get more inverter-related settings, please refer to the inverter user manual first.

1. Power Cable Connection

Step.1

Open the front housing of the deye Sun Series.

Step.2

Connect the red and black cables to the inverter DC connector as shown in Pic 1.1.1.

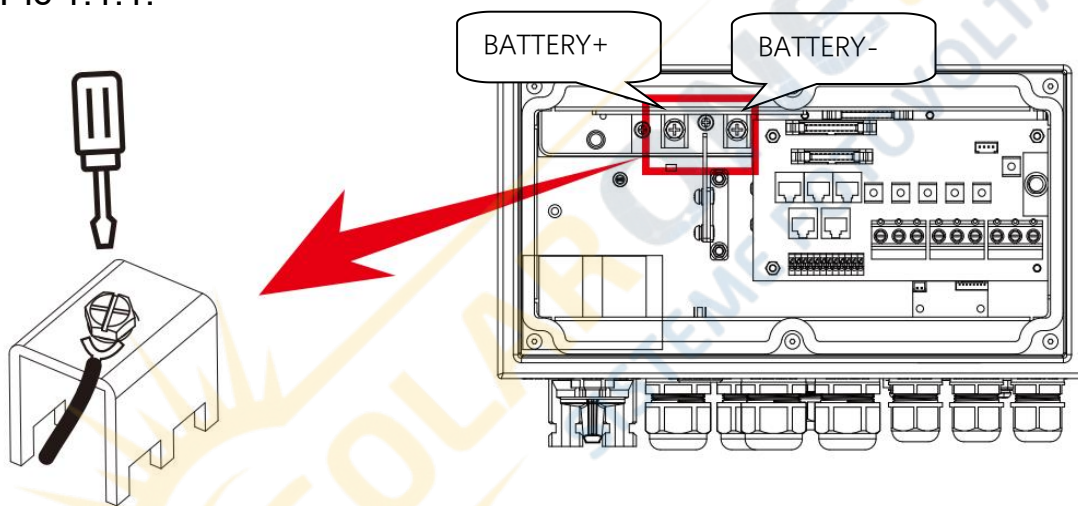

Pic 1.1.1

Step.3

At the other end of the cable, connect to the battery as shown Pic 1.1.2. (Ensure that the battery power switch is off)

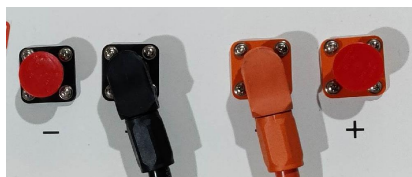

Pic 1.1.2

2. Communication Cable Connection

Connect the end of the cable to the inverter communication port as shown in pic 1.2.1. Make sure which communication port to use.

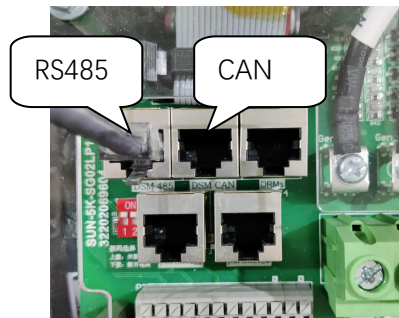

Pic 1.2.1

Connect the other end of the cable to the battery communication port as shown in pic 1.2.1. (Ensure the correct sequence of wires inside the communication cable)



Pic 1.2.2

3. Set The DIP Switch

Set the DIP switch as shown in graphic 1



Pic 1.2.3



graphic 1

4. Start up the system

Start up the inverters and batteries.

5. Change the battery setting of the inverter

※ **CAUTION:** If you want more details about the batteries settings, please check the operating manual of inverters.

Step1.

Change the battery type to lithium in the Battery setting.

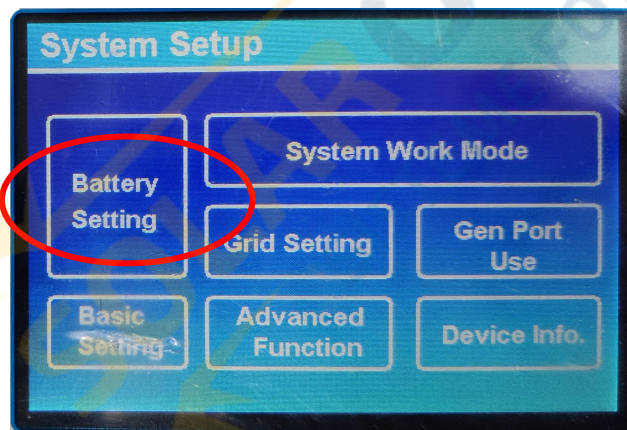

Pic 2.2.1

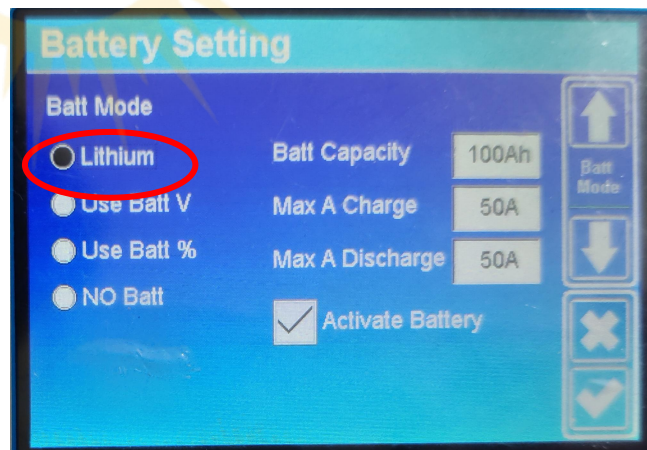

Pic 2.2.2

Step2.

Turn to the next page,you can set charge starting SOC and current.

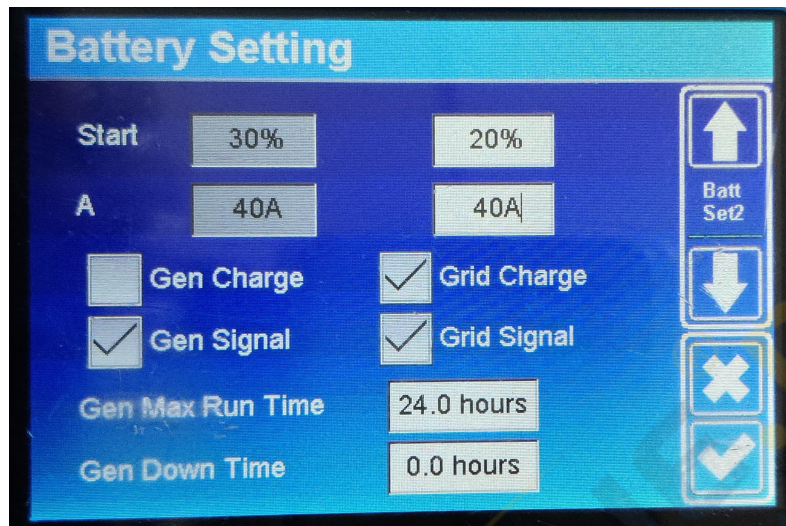

Pic 2.2.3

Step3.

Turn to the next page,set the lithium mode to 12 if you use RS485 communication. If you use CAN communication.set the lithium mode to 00.

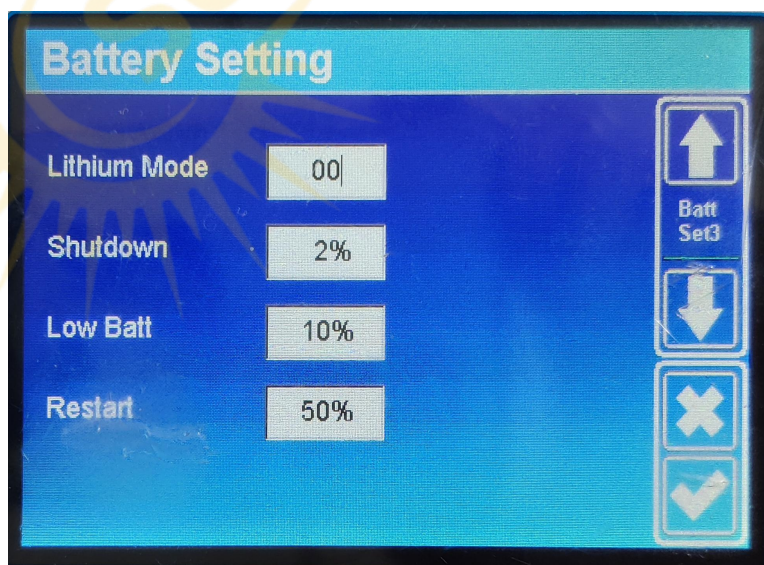

Pic 2.2.4

6. Check the battery soc

Step.1

Touch the battery icon of the inverter's touch panel.

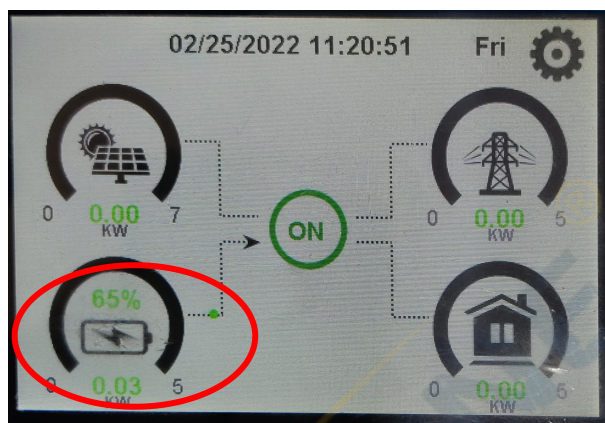

Pic 3.1.1

Step.2

Click the Li-BMS in battery information page.

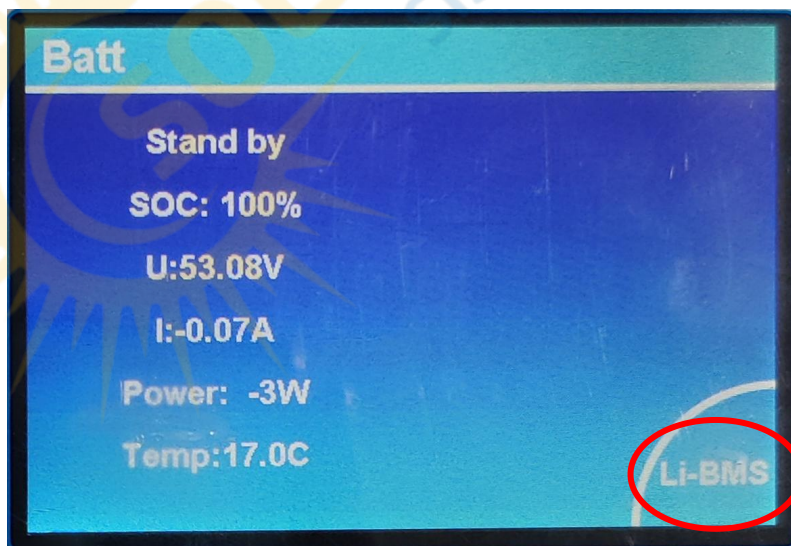

Pic 3.1.2

The details of the battery will be shown on the parameter if the connection between battery and inverter is correct.

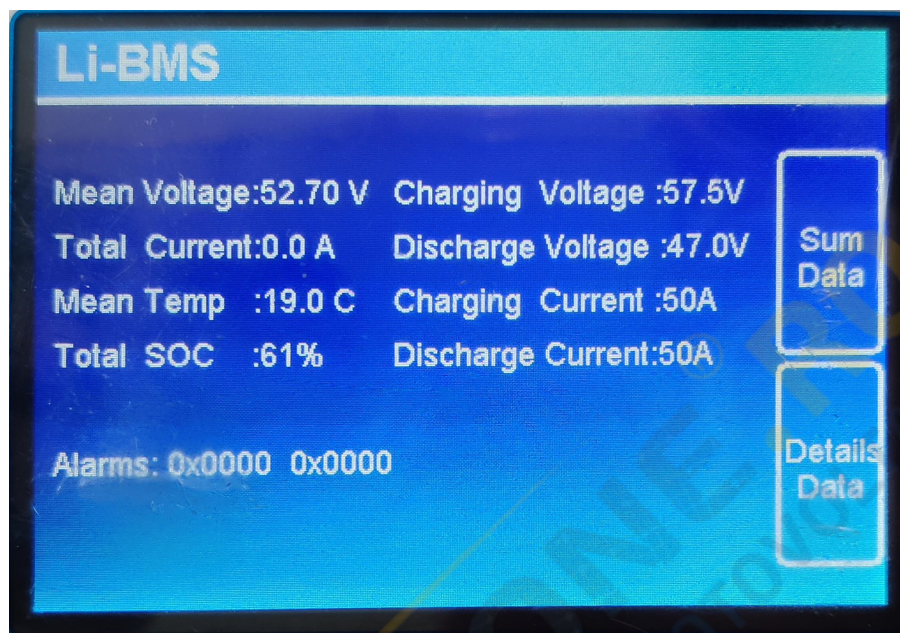

Pic 3.1.3

7. System monitoring

※ **CAUTION:** If you want more details about system monitoring , please check the operating manual of inverters.

Download the app from the app store.



Pic 3.2.1

Register a new account and create a new plant.

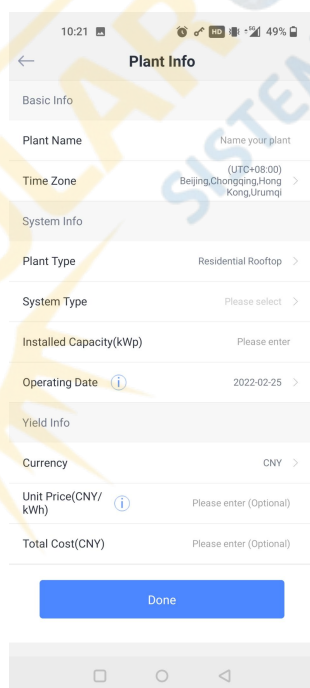
The image is a screenshot of a mobile application interface titled 'Plant Info'. It shows a registration form with the following fields: 'Plant Name' (with a hint 'Name your plant'), 'Time Zone' (with a dropdown menu showing '(UTC+08:00) Beijing,Chongqing,Hong Kong,Urumqi'), 'System Info' section containing 'Plant Type' (dropdown with 'Residential Rooftop'), 'System Type' (dropdown with 'Please select'), 'Installed Capacity(kWp)' (input field with 'Please enter'), and 'Operating Date' (input field with '2022-02-25'). Below this is a 'Yield Info' section with 'Currency' (dropdown with 'CNY'), 'Unit Price(CNY/kWh)' (input field with 'Please enter (Optional)' and an info icon), and 'Total Cost(CNY)' (input field with 'Please enter (Optional)'). A blue 'Done' button is at the bottom of the form. The top of the screen shows the time '10:21' and battery level '49%'. A large, semi-transparent watermark 'SOLAR ONLINE SYSTEME PHOTOVOLTAÏCE' is overlaid diagonally across the screenshot.

Pic 3.2.2

Add the serial number and the password of the Datalogger.



Pic 3.2.3

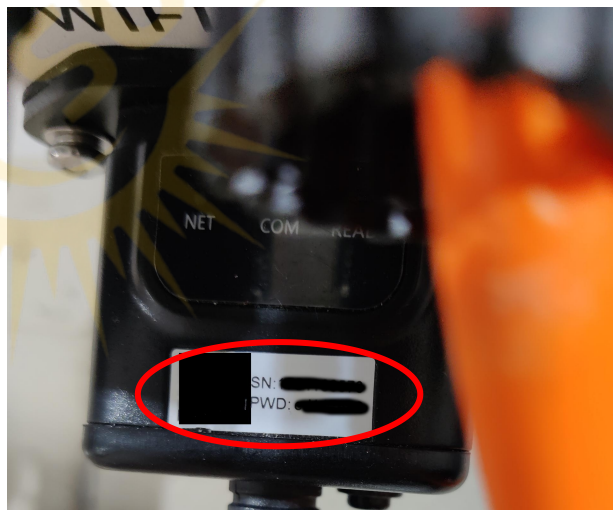

Pic 3.2.4

Now you can monitor the data of solar- PV grid system

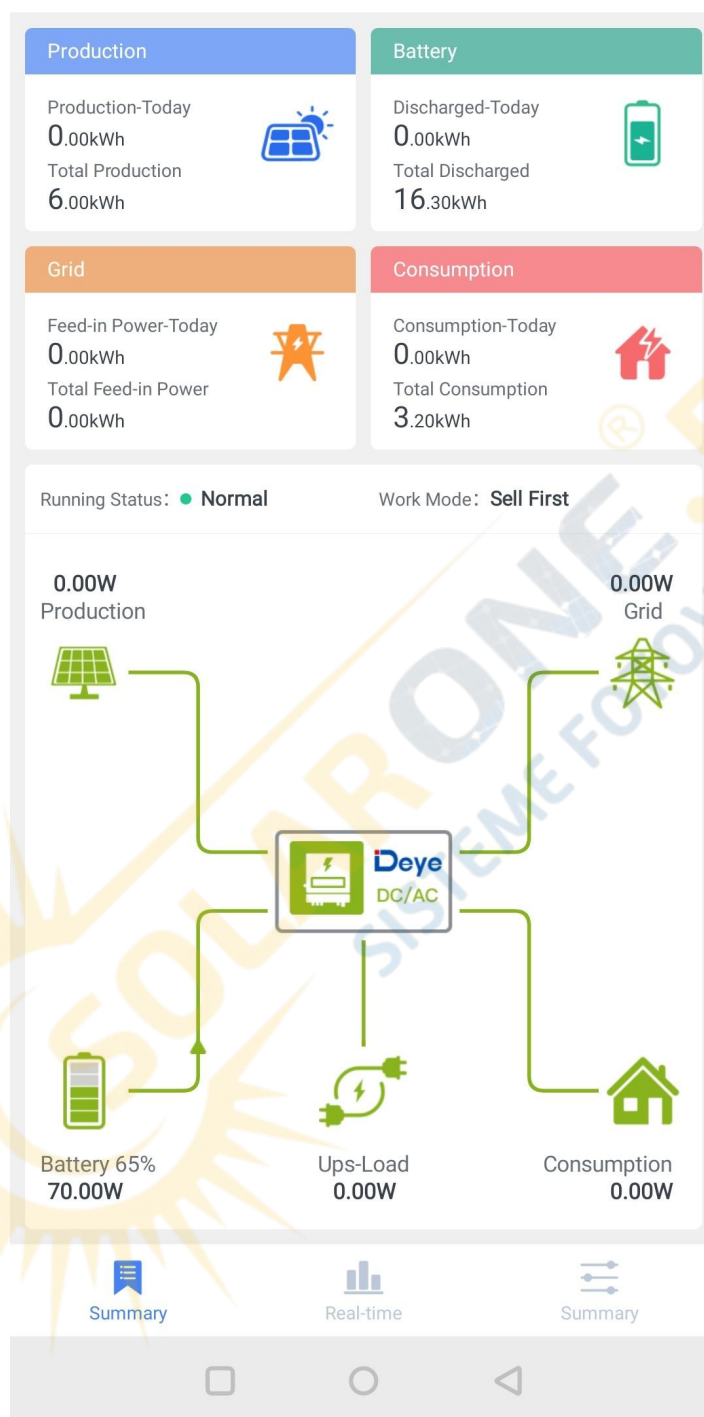

Pic 3.2.5

-END-