

# SmartGuard

63A-(T0, AUT0)

**EN Quick Guide**  
**ZH 快速指南**



Scan for support  
扫码获取支持

## 1 EN Installation Requirements ZH 安装要求

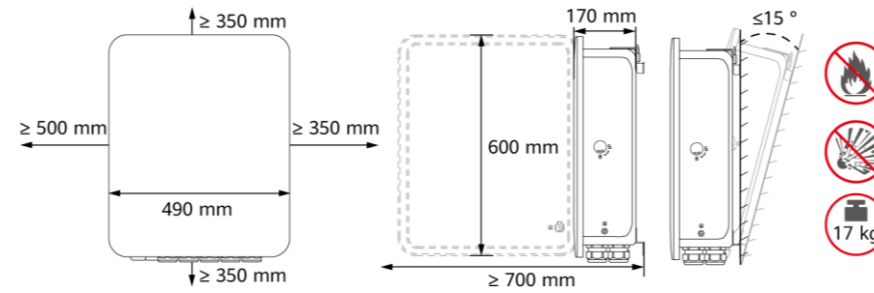

## 2 EN Loads Connected to the SmartGuard ZH 负载分类接入备电盒

Main circuit breaker 入户总开关	1	2
$\leq 63$ A	✓	✓
$> 63$ A	✗	✓

**EN** If the power of backup loads exceeds the maximum off-grid power of the system, the inverter may shut down due to overload. In this case, you need to shut down some loads or connect unimportant loads to the non-backup load port.

**ZH** 备电负载的功率超过系统离网运行最大功率，逆变器可能会过载关机，需要关闭一些负载才能离网运行。或者将不重要负载接入非备电端口。

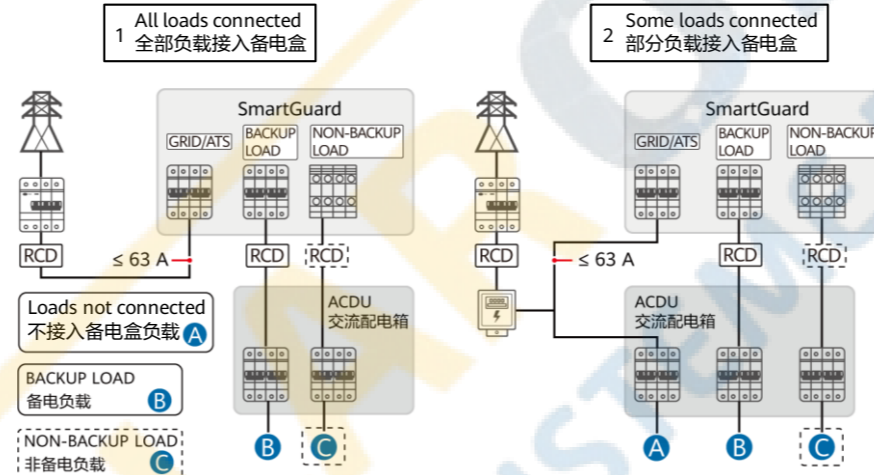

## 3 EN Installing the Device ZH 安装设备

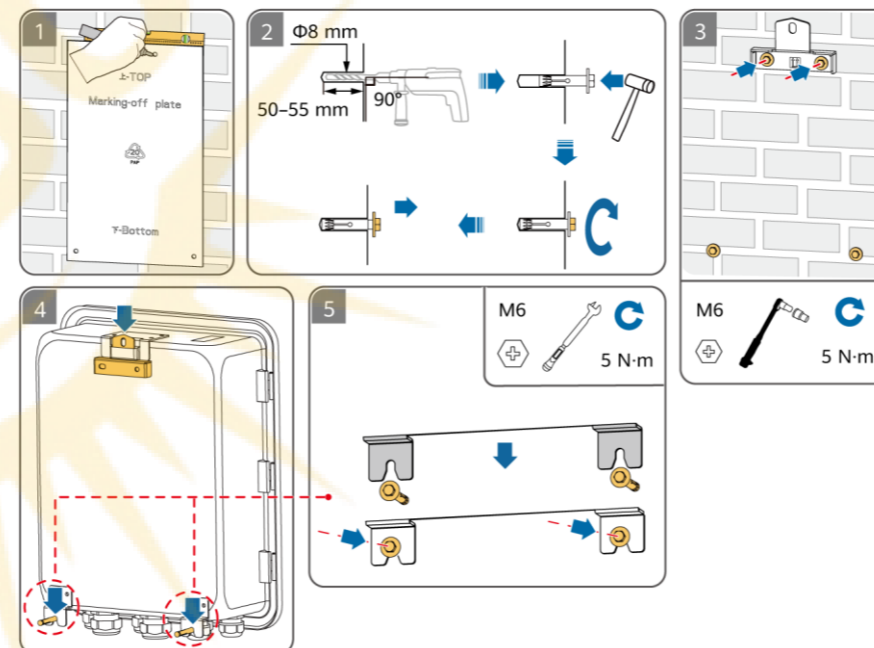

## 4 EN Installing a PE Cable ZH 安装保护地线

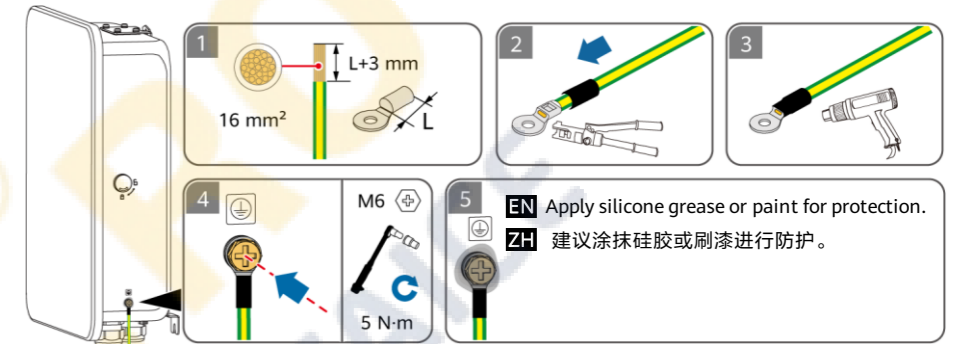

## 5 EN Opening the Maintenance Compartment ZH 打开维护腔

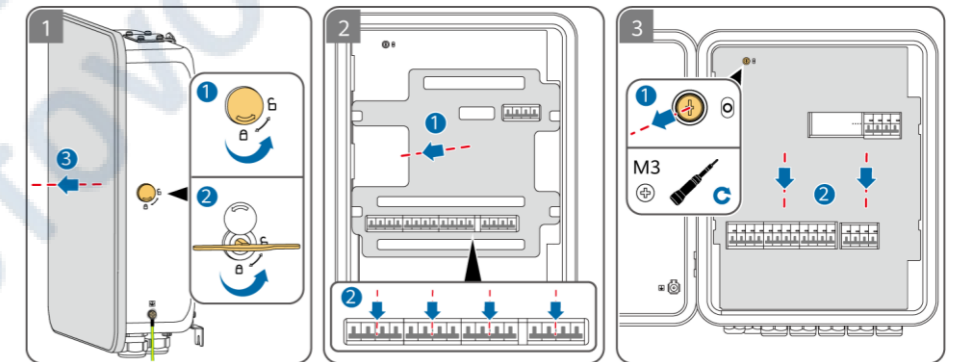

## 6 EN Preparing AC Power Cables ZH 准备交流线缆

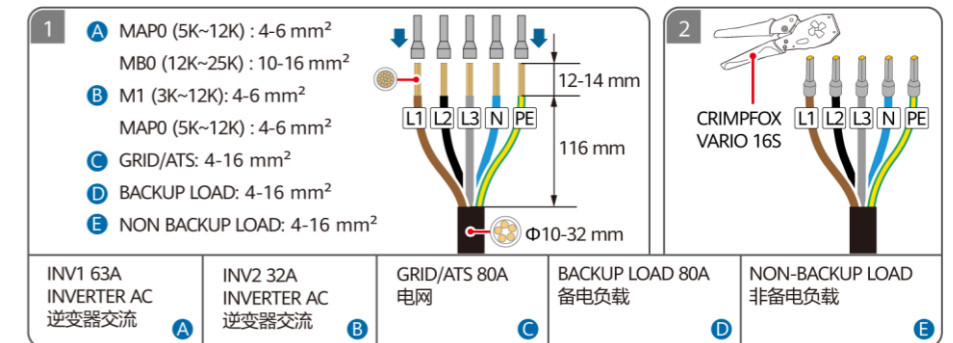

## 7 EN Preparing Signal Cables ZH 准备信号线缆

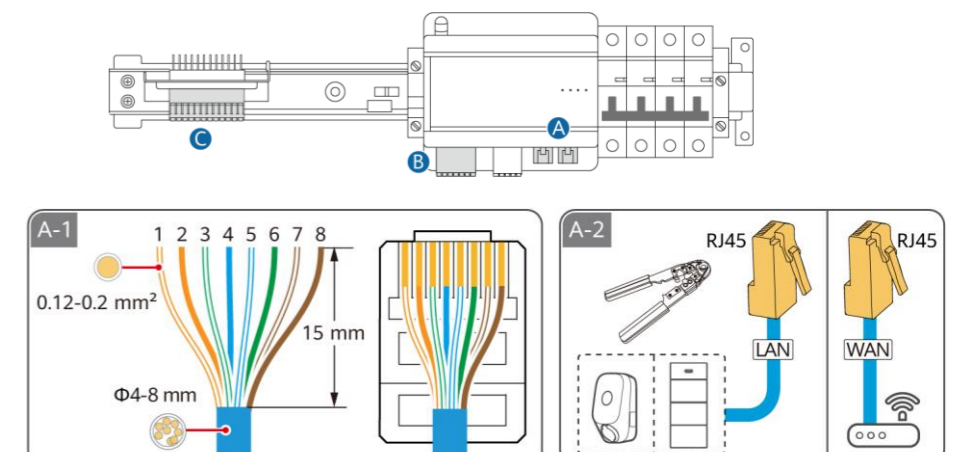

**EN** Before installing the equipment, read the user manual carefully to get familiar with product information and safety precautions. The product warranty does not cover equipment damage caused by failure to follow the storage, transportation, installation, and usage guidelines specified in this document and the user manual. Scan the QR code on the equipment to view the user manual and safety precautions. The information in this document is subject to change without notice. Every effort has been made in the preparation of this document to ensure accuracy of the contents, but all statements, information, and recommendations in this document do not constitute a warranty of any kind, express or implied.

**ZH** 安装设备前请仔细阅读用户手册，了解产品信息及安全注意事项。未按照本文档与用户手册的内容存储、搬运、安装和使用设备而导致设备损坏，不在设备质保范围内。您可以扫描机身处的“扫码获取支持”二维码，查阅用户手册和安全注意事项等信息。由于产品版本升级或其他原因，本文档内容会不定期进行更新。除非另有约定，本文档仅作为使用指导，文档中的所有陈述、信息和建议不构成任何明示或暗示的担保。

## 8 EN Electrical Connections

## ZH 电气连接

EN Connect the signal cables.  
ZH 信号线连接。

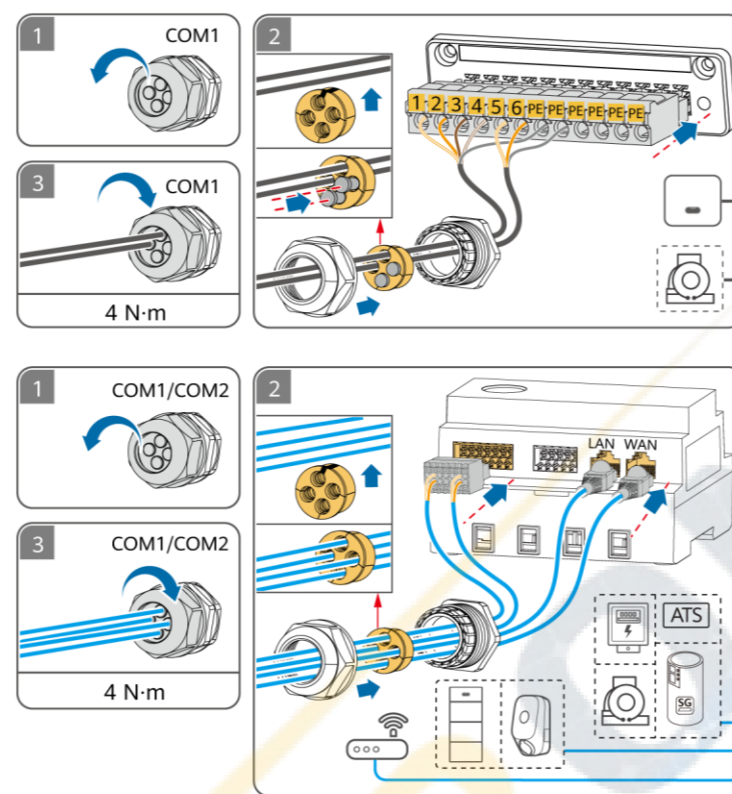

**EN** • RCD: A residual current device (RCD) must be installed before the backup load. During off-grid operation, the main circuit breaker does not provide protection. Electric leakage on the load may result in electric shocks.  
• NON-BACKUP LOAD: Both single-phase loads and three-phase loads can be connected to this port.  
• The PEN of the SmartGuard-63A-T0 backup load port must be connected to the ground bar of the ACDCU. Do not connect the PEN of the SmartGuard-63A-AUT0 backup load port to the ground bar.

**ZH** • 漏电保护开关 (RCD): 备电负载前必须安装漏电保护开关, 当离网运行时, 入户总空开的漏电保护会失去保护作用, 负载发生漏电可能导致电击危险。  
• 非备电负载: 单相负载和三相负载都支持。  
• SmartGuard-63A-T0备电端口的PEN必须连接交流配电箱的接地排, SmartGuard-63A-AUT0备电端口的PEN不连接。

EN Connect the AC cables.  
ZH 交流线连接。

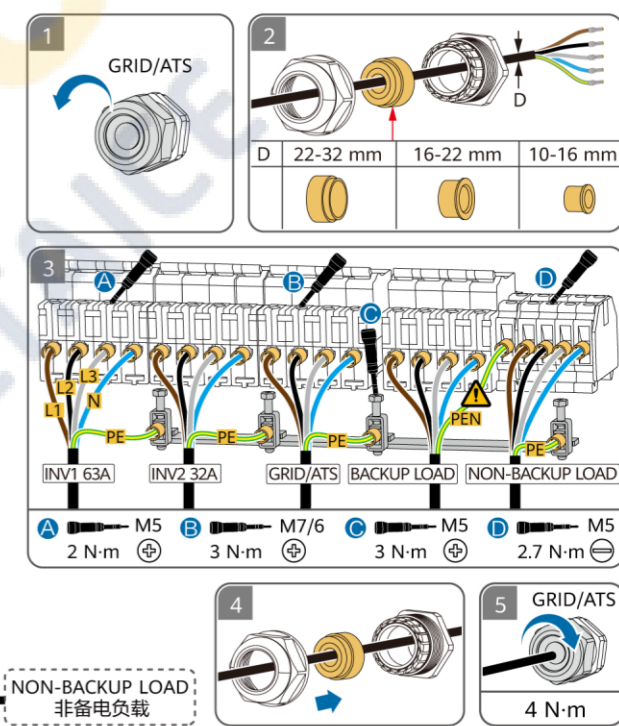

	MAP0	M1	MB0
Single-phase load 单相负载	⊗	⊗	⊗
Three-phase load 三相负载	⊗	⊗	⊗

Model	Qty.	SmartGuard	External AC switch 外置交流开关	AC Cable Diameter 交流线径
SUN2000-(12K-25K)-MB0	1	INV1 63A: 1	⊗	10 mm <sup>2</sup> -16 mm <sup>2</sup>
SUN5000-(17K, 25K)-MB0	1	INV1 63A: 1	⊗	
SUN2000-(3KTL-12KTL)-M1	1	INV2 32A: 1	⊗	4 mm <sup>2</sup> -6 mm <sup>2</sup>
SUN2000-(5KTL-12KTL)-MAP0	1	INV2 32A: 1	⊗	
	2	INV1 63A: 1 INV2 32A: 1	⊗	
SUN5000-(8KTL, 12KTL)-MAP0	1	INV1 63A: 2 INV2 32A: 1	⊗	
	2	INV1 63A: 1 INV2 32A: 1	⊗	
	3	INV1 63A: 2 INV2 32A: 1	⊗	

**EN** Inverter (INV): Connect the inverter to the SmartGuard based on the INV1/INV2 port requirements. Only the MAP0 series supports parallel connections of up to three inverters, but the SUN2000-(5KTL-12KTL)-MAP0 and SUN5000-(8KTL, 12KTL)-MAP0 cannot be used together. If the AC input power cables recommended for the inverter are used and the AC switch on the SmartGuard does not match the AC switch on the inverter, install an AC switch as required by the inverter to ensure that the inverter can be safely disconnected from the SmartGuard when an exception occurs.

**ZH** 逆变器 (INV): 请按INV1/INV2端口要求, 将逆变器接入备电盒, 仅MAP0逆变器支持≤3台并网, SUN2000-(5KTL-12KTL)-MAP0和SUN5000-(8KTL, 12KTL)-MAP0逆变器不支持混合并网。如果使用逆变器推荐规格的交流输入线, 当备电盒交流开关和逆变器交流开关电流不匹配, 请按逆变器要求加装交流开关, 确保发生异常情况时, 逆变器与备电盒可以安全断开。



**Huawei Digital Power Technologies Co., Ltd.**  
Huawei Digital Power Antuoshan Headquarters  
Futian Shenzhen 518043  
People's Republic of China  
digitalpower.huawei.com

**华为数字能源技术有限公司**  
深圳市福田区华为数字能源安托山基地  
邮编: 518043  
digitalpower.huawei.com

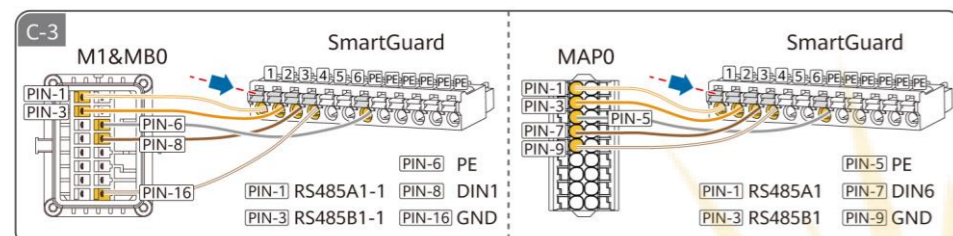
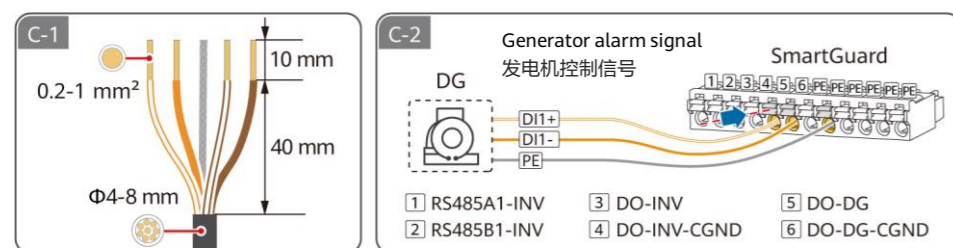
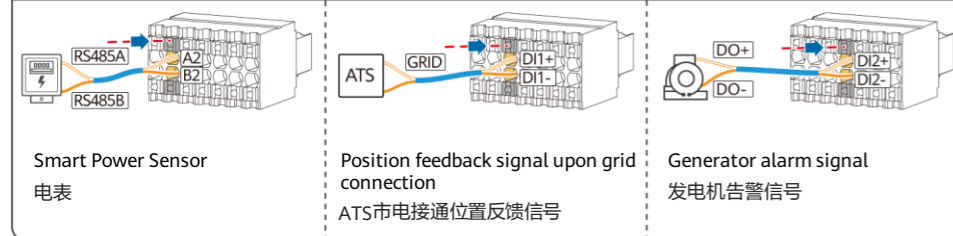
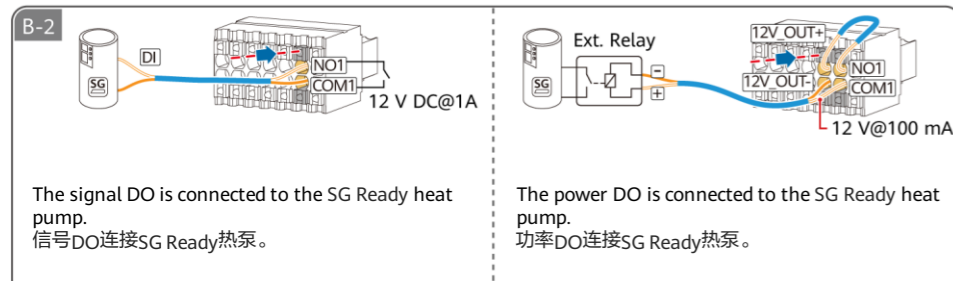
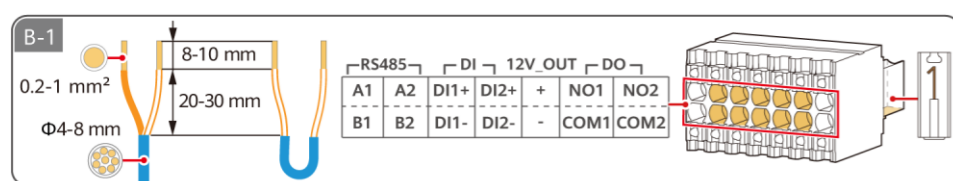

EN For details about how to install smart appliances, see the Residential Smart PV Solution User Manual (EMMA). You can obtain the document by scanning the QR code in this quick guide.  
ZH 智能用电安装请参考《户用智能光伏解决方案用户手册 (EMMA)》, 扫描本文档二维码获取。

## 9 EN Turning On Switches and Closing the Door

## ZH 闭合开关&关门

EN During deployment and normal operation, do not operate the bypass switch. When the grid is available but the SmartGuard is abnormal and cannot supply power to loads, set the bypass switch by referring to the user manual.  
ZH 在开局和正常使用时, 请勿操作旁路开关。当电网有电, 备电盒无法正常给负载供电, 参考用户手册操作旁路开关。

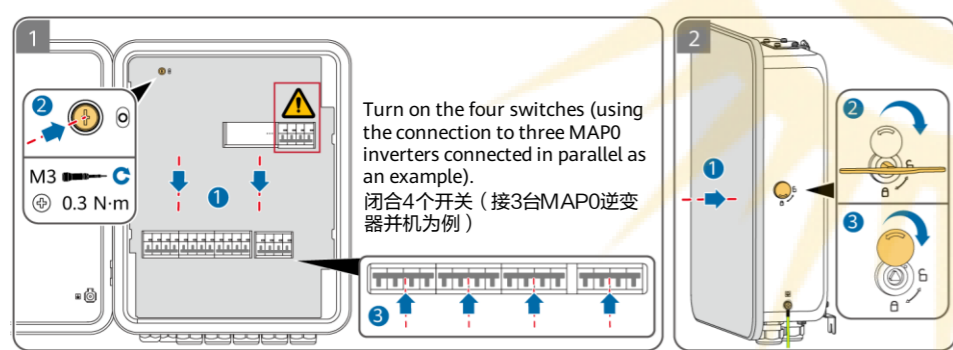

## 10 EN Power-On and Commissioning with Mains Power

## ZH 有市电上电调测

EN For power-on and commissioning without mains power, see the user manual.  
ZH 无市电上电调测步骤参考用户手册。

