

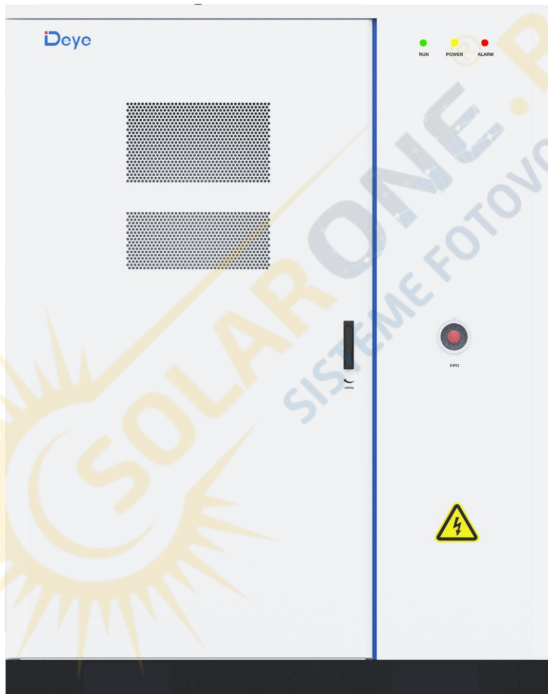

Installation Guide and User Manual
**GE-F120-2H2 solar & Battery
energy storage system**



Issue: 02

Date: 20250522

Contents

All Rights Reserved	3
About This Manual	3
1. Safety Precautions	5
1.1 Electrical Safety	5
1.2 Battery Safety	6
1.3 Hoisting and Transportation	6
1.4 Installation and Wiring	6
1.5 Operation and Maintenance	6
1.6 Disposal of Waste	6
2. Product Description	7
2.1 Product Introduction	7
2.2 External Design	7
2.3 Air-conditioner Design	9
2.4 Internal Design	10
2.4.1 Internal Equipment	10
2.4.2 Battery Introduction	11
2.4.3 Indicator light Design	15
3. Transport and storage	18
3.1 Transportation	18
3.2 Transportation Requirement	18
3.3 Storage requirement	19
4. Mechanical Installation	20
4.1 Inspection Before Installation	20
4.1.1 Deliverables Inspection	20
4.2 Installation Environment	21
4.3 Installation Spacing Requirement	22
4.4 Foundation requirements	24
4.5 Transportation and lifting	26
4.5.1 Transportation	26
4.5.2 Hoisting Equipment	28
4.5.3 Hoisting	29
4.6 Fixing Methods	30
5. Electrical connection	32
5.1 Cabinet DC expander (System)	32
5.2 Electrical connection Overview	33
5.3 Preparation before connection	34

5.4 Cables are connected to a single cabinet	35
5.4.1 Cable connections inside BESS	35
5.4.2 Ac power distribution cable connection	38
5.4.3 PV Module Wire connection	39
5.4.4 Topological schematic diagram	43
5.4.5 Power supply connection guide for backup power supply of fire alarm system	44
5.4.6 GE-F120 and GE-F60 are connected in parallel.....	45
5.4.7 GE-F120 and GE-F60 parallel auxiliary power supply wiring diagram.....	46
5.4.8 Auxiliary Wiring (GE-F120 connected to 2 GE-F60)	47
5.4.9 Auxiliary Wiring (GE-F120 connected to 3 GE-F60).....	48
5.4.10 Auxiliary Cable (GE-F120 connected to 4 GEF60).....	49
5.4.11 Description of communication cables connecting GE-F120 and GE-120 cabinets	50
5.4.12 GE F120 and GE 120 combined AC power distribution cables are connected	51
5.4.13 Wiring instructions for diesel power generation	52
5.4.14 CT connection instructions	53
5.5 Operation after cable connection	54
5.6 Battery Connection	54
6. Activate BESS	55
6.1 Power-on procedure	55
6.2 Power-off procedure	56
6.3 Unplanned (emergency) shut down	57
7. Fire Suppression system	58
7.1 Fire flow chart	58
7.2 Fire Suppression equipment	59
7.2.1 Aerosol fire suppression system	59
7.2.2 Fire suppression water pipe system	60
8. Troubleshooting	62
9. Hybrid Inverter Instructions	65
10. Inspection, cleaning and maintenance	66
10.1 Basic Information	66
10.2 Maintenance item and period	66
10.3 Battery Maintenance	68
11. Battery recycling	71
11.1 Recovery process and steps of cathode materials	71
11.2 Recovery of anode materials	71
11.3 List of recycling equipment	71
12. Appendix	72
12.1 System Parameter	72
12.2 Contact Information	73

All Rights Reserved

No part of this document can be reproduced in any form or by any means without the prior written permission of NINGBO DEYE ESS TECHNOLOGY CO., LTD (-hereinafter "Deye ESS").

Trademarks

Deye and other Deye trademarks used in this manual are owned by Deye ESS.

All other trademarks or registered trademarks mentioned in this manual are owned by their respective owners.

Software Licenses

- It is prohibited to use data contained in firmware or software developed by Deye ESS, in part or in full, for commercial purposes by any means.
- It is prohibited to perform reverse engineering, cracking, or any other operations that compromise the original program design of the software developed by Deye ESS.

Disclaimer

DEYE ESS TECHNOLOGY CO., LTD shall not be liable for personal injury, property loss, product damage and subsequent losses under the following circumstances.

- Failure to comply with the provisions of this manual.
- Incorrect use of this product.
- Unauthorized or unqualified personnel repair the product, disassembly the rack and perform other operations.
- Use of unapproved spare parts.
- Unauthorized modifications or technical changes to the product.

About This Manual

This manual describes the transportation and storage, mechanical installation, electrical connection, power-on and power-off operation, troubleshooting, and maintenance of the BESS.

How to Use This Manual

Please read this manual carefully before using the product and keep it properly at a place for easy access.

In order to provide the best customer experience, contents of the manual may be updated and amended continuously, so it is possible that there may be some errors or slight inconsistency with the actual product.

Please refer to the actual product purchased, and the latest manual can be obtained from





service-ess@deye.com.cn (www.deyeess.com) or sales channels.

The figures in this manual are for reference only. The actual product received may differ.

Symbol Explanations

To ensure the safety of the users and their properties when they use the product and to make sure that the product is used in an optimal and efficient manner, this manual provides users with the relevant safety information highlighted by the following symbols.

Below is a list of symbols used in this manual. Please read it carefully to make better use of this manual.

	Danger! Failure to follow the instructions bearing this sign may result in a serious accident resulting in death or serious injury.
	Warning! Failure to follow the instructions of this sign may result in a serious accident resulting in serious personal injury.
	Caution! Failure to follow the instructions of this sign may result in minor or moderate injury.
	Notice! Provide information that is considered important but not relevant to the danger. The information relates to property damage.

This product is designed to an integrated system, which must be performed by a qualified person trained in electrical engineering and familiar with the characteristics and safety requirements of lithium batteries. Do not use this product if you are unsure if you possess the necessary skills to complete this integration.

Abbreviation:

Complete designation	Abbreviations
Battery Module	Module
Battery Pack	Pack
Power Distribution Unit	PDU
Accessory box	/
Energy Storage System	BESS
Battery Base	Base

◆ **Personal Requirements**

The hoisting, transportation, installation, wiring, operation, and maintenance of the BESS must be carried out by professional electrical technicians in accordance with local regulations. The professional technician is required to meet the following requirements:

- Should know electronic, electrical wiring and mechanical expertise, and be familiar with electrical and mechanical schematics.
- Should be familiar with the composition and working principles of the BESS and its corollary equipment.
- Be able to quickly respond to hazards and emergencies that occur during installation and commissioning.
- Be familiar with the relevant standards and specifications of the country/region where the project is located.

1. Safety Precautions

1.1 Electrical Safety



Danger!

- Touching the power grid or the contact points and terminals in the devices connected to the power grid may lead to electric shock! All circuit connectors must be disconnected during maintenance.
 - The battery side or the power grid side may generate voltage. Always use a standard voltmeter to ensure that there is no voltage before touching.
-



Danger!

- Lethal voltages are present inside the product!
 - Note and observe the warnings on the product.
 - Respect all safety precautions listed in this manual and other pertinent document.
 - Respect the protection requirements and precautions of the lithium battery.
-



Danger!

When the power supply is disconnected, there may still be electricity in the battery. Wait for 10 minutes and ensure that the device has no voltage before performing any operation.



Warning!

- All hoisting, transportation, installation, wiring, operation, and maintenance must be carried out complying with the relevant codes and regulations of the country where the project is located.
 - Always use the product in accordance with the requirements described in this manual. Otherwise, equipment damage may occur.
-



Warning!

- All hoisting, transportation, installation, wiring, operation, and maintenance must be carried out complying with the relevant codes and regulations of the country where the project is located.
 - Always use the product in accordance with the requirements described in this manual. Otherwise, equipment damage may occur.
-



Notice!

To prevent accidents caused by misuse or unrelated persons, place necessary warning signs or barriers near the product.

1.2 Battery Safety

It is very important to read the owner's manual carefully before installing or using the battery. Follow any instructions or warnings in this document, otherwise it may result in electric shock, serious injury, or death, or may damage the battery and render it inoperable.

After the battery is fully discharged, it needs to be charged within 48 hours. The battery is not charged as required, resulting in loss of battery capacity or irreversible damage. If the battery is stored for a long time, it is required to be charged every six months, and the SOC should not be less than 50%.

- Do not use cleaning solvents to clean batteries. Do not expose the battery to flammable or irritating chemicals or vapors.
- Do not connect the battery directly to the photovoltaic solar power wire.
- Do not paint any part of the battery, including any internal or external components.
- Please do not use batteries provided by the company with other batteries, including but not limited to batteries of other brands or batteries with different rated capacities.
- Do not insert any foreign matter into any part of the battery.
- Handle or handle with care to avoid battery damage, drop, or leakage.
- Do not store batteries with inflammable and explosive materials. This may cause product damage or property loss.

Maintain the battery according to this manual. Deye ESS is not responsible for insurance and claims if maintenance is not performed in accordance with this manual.



1.3 Hoisting and Transportation

Follow the procedure of work of heights when walking on the top of the container.

1.4 Installation and Wiring

In the whole process of mechanical installation, the relevant standards and requirements of the project location must be strictly observed.

Please refer to the wiring method recommended by Deye ESS.

1.5 Operation and Maintenance

Personal protective equipment must be equipped when maintaining and maintaining the BESS. Maintenance personnel must wear protective equipment such as goggles, helmets, insulating shoes, and gloves.

Users are not allowed to perform battery maintenance without guidance. Warning Except the maintenance operations described in this manual, do not perform other maintenance operations to avoid electric shock. If necessary, please contact Deye ESS Customer Service center for maintenance.

Removing or repairing the battery may cause the battery to catch fire. The replacement of internal parts must be carried out by professionals. Do not spray paint internal or external parts of the product. Do not use cleaning agents to clean products or expose them to harsh chemicals.

1.6 Disposal of Waste

When the equipment is at the end of its service life, it cannot be disposed of together with domestic waste. Some parts can be recycled, and some parts will cause environmental pollution.

2. Product Description

2.1 Product Introduction

GE-F120 lithium iron phosphate battery the new energy storage products developed and produced by DEYE ESS, which can be used to support the reliable power supply of various equipment and systems. The GE-F120 is particularly suitable for high-rate cyclic charging and discharging scenarios.

GE-F120 is integrated with 50kW PCS from Deye.

GE-F120 has built-in local management system, it can manage and monitor, voltage, current, temperature, humidity, smoke, etc. In addition, BMS also balances the capacity of the battery and extends the cycle life of the system. Meanwhile, support black start function, Off grid operation, and built-in aerosol fire suppression device and combustible gas detection exhaust system. Multiple battery systems can be expanded in parallel for greater capacity and longer power support duration requirements.

A single GE-F120 can be parallel with a maximum of four GE-F60 DC machines, and a maximum of ten GE-F120 AC machines can be parallel.

2.2 External Design

Cabinet Appearance

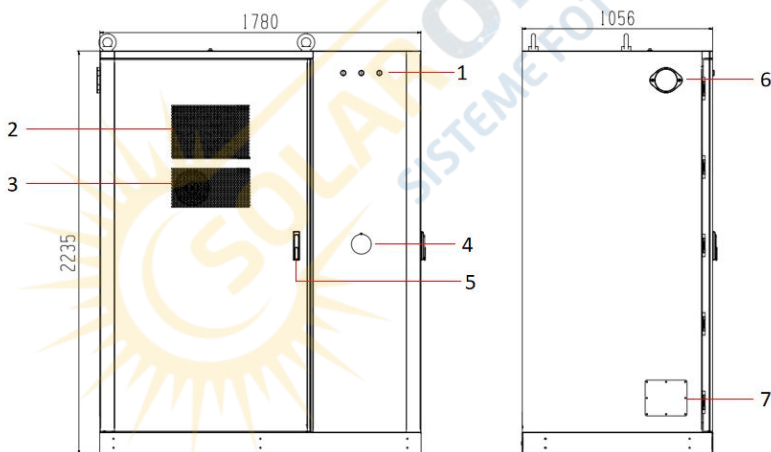

Unit: mm

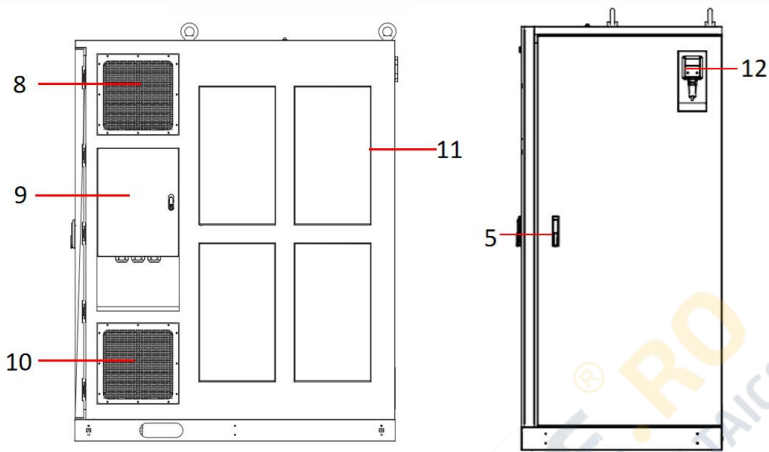

<p>① Indicator light: Green: The system is running properly. Yellow indicator: The system is powered on, indicating danger. Red: The system is faulty and needs to be detected.</p>	<p>⑦ Cable outlet: Connect to F60 parallel cable outlet port.</p>
<p>② Air conditioning outlet: Hot air in the air conditioner comes out from this outlet.</p>	<p>⑧ Electrical compartment air outlet: The heat from the distribution bin comes out of this opening.</p>
<p>③ Air conditioning inlet: Outdoor air enters air conditioner through this opening.</p>	<p>⑨ Distribution box: Equipment used for power distribution and control.</p>
<p>④ Emergency stop switch: If the system is faulty or needs to be powered off in an emergency, press the emergency button.</p>	<p>⑩ Electrical compartment air inlet: Outdoor air enters the distribution bin through this port</p>
<p>⑤ Door switch</p>	<p>⑪ Explosion relief plate: When the combustible gas generated by the thermal runaway of the battery cell explodes, the directional detonation is carried out to ensure that the main structure of the product is not damaged, and the life safety of the property and surrounding personnel is guaranteed.</p>
<p>⑥ Breather Valve: When the concentration of combustible gas detected exceeds the standard, open the exhaust valve and discharge the combustible gas outside the device to ensure that the system does not catch fire or explode.</p>	<p>⑫ WIFI Capture Stick: The reception and transmission of wireless signals convert wired network signals into wireless network signals.</p>

2.3 Air-conditioner Design

System built-in air conditioner cooling

The air conditioning system uses air cooled air conditioner, keep the BESS at a constant temperature.

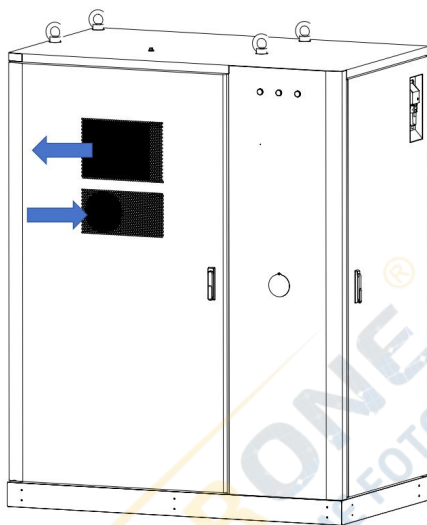

Energy storage Air Conditioning	
Model:	DY-CNA20-BP
Rated Voltage:	AC 220V-240V
Rated Frequency	50/60Hz
Rated Cooling Capacity:	2100W
Rated Heating Capacity:	1650W
Rated Cooling Power Input:	900W
Rated Heating Power Input:	1700W
Rated Cooling Current:	4.15A
Rated Heating Current:	7.9A
Max.Power:	1800W
Max.Current:	8.3A
Max Operating Pressure	2.7Mpa
Max.Suction Pressure	1.6Mpa
Max.Discharge Pressure	2.7Mpa
Air Flow Volume	630m ³ /h
Electric Shock Prevention	I
Refrigerant	R134a/330g
Water-proof Class	IP55
Dimension (W×H×D)	478×796×306mm
Net Weight	48.5kg

2.4 Internal Design

2.4.1 Internal Equipment

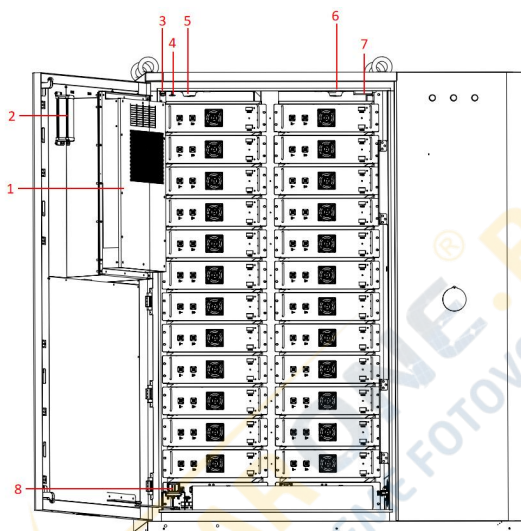

① Air conditioner	Cooling the BESS.
② Aerosol Fire Suppression Device	When the BESS is detected to be on fire, aerosol is emitted to extinguish the fire.
③ Travel switch	Check whether the BESS's door is closed.
④ Fire suppression water pipe	Fire suppression and cooling.
⑤ Heat detector	A device used to measure temperature and sound an alarm if it detects excessive.
⑥ Smoke detector	A device used to detect smoke in a fire and sound an alarm when smoke is detected.temperature.
⑦ Combustible gas detector	Detect the concentration of combustible gases in the air
⑧ Manual service disconnect	In order to protect the safety of technicians servicing in high voltage environments or respond to sudden events, the connection of the high voltage circuit can be quickly separated.

2.4.2 Battery Introduction

Battery Module

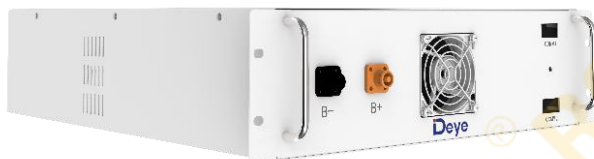

Battery Type	LiFePO ₄ (LFP)
Nominal Voltage	51.2Vdc
Rated Capacity	100Ah
Rated Energy	5.12kWh
Nominal Charge/Discharge Current	100A
Peak. Discharge Current	125A
Charge Temperature	0~55°C
Discharge Temperature	-20°C~55°C
Storage Temperature	0°C~35°C
Ingress Protection	IP20
Dimension (W/D/H)	440*570*133mm
Weight Approximate	45kg

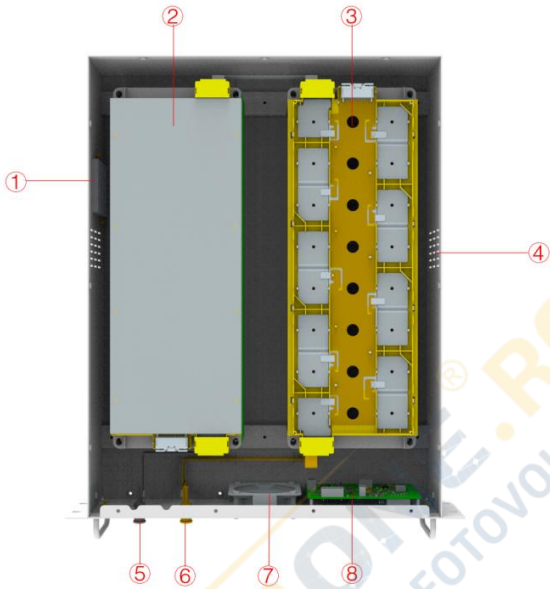

①Aerosol Fire Suppression Device	When the BESS is detected to be on fire, aerosol is emitted to extinguish the fire.
②Battery module	Provides electrical energy storage and output
③CCS	Cells Contact System
④Vent hole	Heat dissipation
⑤Battery Negative-	/
⑥Battery Positive+	/
⑦Fan	Promote internal and external air flow
⑧BMU	Battery monitoring

Power Distribution Unit



Operating Voltage	120~750Vdc
Nominal Charge/Discharge Current	100A
Max. Charge/Discharge Current	125A
DC Input Rating	12±2%V/4.15A
Operating Temperature Range	-20~65°C
Ingress Protection	IP20
Dimension (W/D/H)	440*570*150mm
Weight Approximate	17kg

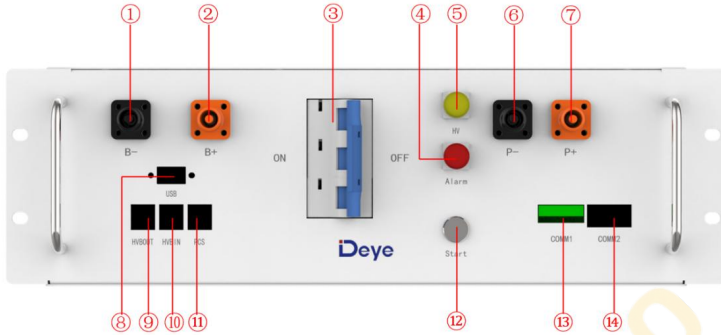

①B-	Connection position of the common negative pole of the battery
②B+	Connection position of the common positive pole of the battery
③Air switch	Used to manually control the connection between the battery rack and external devices
④ALRM light indicator	Battery system fault alarm indicator
⑤HV light indicator	High-voltage hazard indicator
⑥PCS-	Connection position of PCS negative pole
⑦PCS+	Connection position of PCS positive pole
⑧USB	BMS upgrade interface and storage expansion interface
⑨OUT COM	Connection position with next GE-F-PDU communication output
⑩IN COM	Connection position with previous GE-F-PDU communication input
⑪PCS COM	Communication interface with charging and discharging equipment
⑫START	A start switch of 12VDC power inside the high-voltage control box
⑬COMM1	Communicative connection with the cabinet
⑭COMM2	Communicative connection with the first battery module; and providing 12VDC power for the first battery module.

2.4.3 Indicator light Design

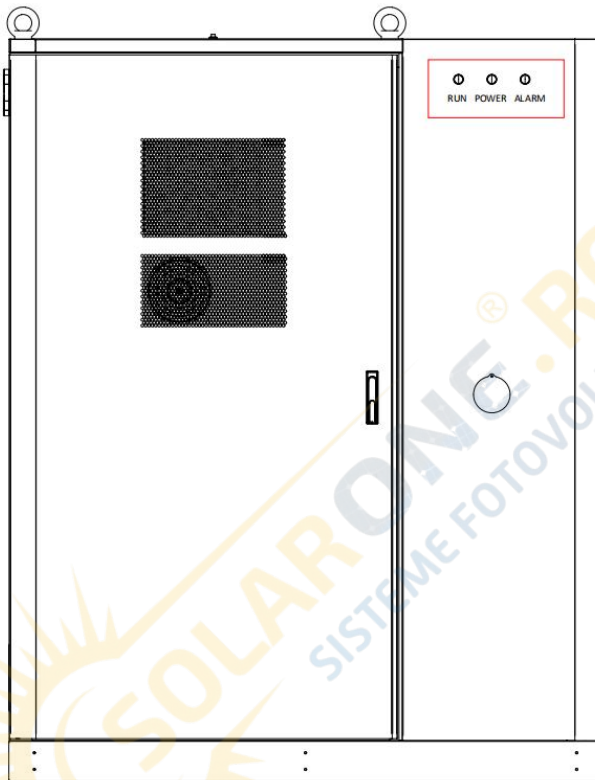

1.RUN indicator: indicates that the BESS is running normally.

2.POWER light: indicates that BESS power with high voltage, need to pay attention to protection and safety.

3.The following faults trigger Level-2 faults. The cabinet ALARM is on red, the external alarm is on, and the RUN indicator is off. The system does not work. For details, see Table 1-1.Emergency stop press fault, flammable gas fault detected, water flooding fault detected, temperature exceeding fault detected, smoke fault detected, gas communication lost, meter communication lost, IO board communication lost, air conditioning communication lost, the maximum temperature of the battery cell greater than 65°, these faults will also trigger the BESS external fault light, running light off.

Table 1-1

1	System fault	18	Discharge relay adhesion	35	Sensor second alarm (Temperature sensor and smoke sensor)
2	Charging current fault	19	Charge relay adhesion	36	Emergency stop press fault
3	Charging current fault	20	Heating relay adhesion	37	Detected combustible gas fault
4	Charging overtemperature fault	21	Extreme protection	38	Detected water sensor fault
5	Discharging overtemperature fault	22	Abnormal supply voltage	39	Detected smoke sensor fault
6	Charging low temperature fault	23	Main positive relay adhesion	40	Pre-charge failed fault
7	Discharging low temperature fault	24	blown fuse	41	The Charging voltage is too low
8	Pressure difference too large fault	25	BMU repeat fault	42	BMU communication fault
9	Temperature difference too large fault	26	BMU repeat fault	43	BMU number anomaly
10	High SOC fault	27	Internal CAN communication fails	44	Abnormal Mot total pressure collection
11	Cell temperature low voltage fault	28	PCS CAN Communication fails	45	Abnormal Temperature collection of the BMS connector
12	Pre-charge resistance temperature too high	29	Abnormal PCS RS485 communication	46	Abnormal Temperature collection of the BMU connector
13	Insulation fault	30	Abnormal external total pressure collection	47	EEPROM storage fault
14	Heating film is too high fault	31	Abnormal internal total pressure collection	48	RTC clock fault
15	SOC too low fault	32	Abnormal SCHG total pressure collection	49	Current module fault
16	Total voltage too high fault	33	Voltage acquisition fault	50	Current acquisition fault
17	Total voltage too high fault	34	Temperature acquisition fault	51	Detect temperature exceedance fault

4. The air conditioner is offline, the BESS external ALARM light is on, and the RUN light is off.
5. The following faults occur in the air conditioner. The BESS external ALARM light is on and the RUN light is off.

Table 1-1

1	High temperature alarm	9	Internal ambient temperature 1 fault	17	Inner coil temperature protection
2	Low temperature alarm	10	Internal ambient temperature 2 fault	18	Internal fan failure
3	High humidity alarm	11	Internal ambient humidity 1 fault	19	Internal fan communication fault
4	Low humidity alarm	12	Internal ambient humidity 2 fault	20	Internal fan overloaded fault
5	Electric heating protection	13	Inner coil temperature fault	21	External fan failure
6	Outdoor ambient temperature fault	14	Pressure sensor failure	22	External fan communication fault
7	Outer coil temperature fault	15	High exhaust temperature protection	23	External fan overloaded fault
8	Exhaust temperature fault	16	Outer coil temperature protection	24	Compressor startup failure
				25	Compressor communication failure

3. Transport and storage

3.1 Transportation

1 Preventive Measures

Failure to ship and store products in accordance with the requirements of this manual may void the warranty.

2 Mode of Transportation

It can be transported by cars, trains and ships.

3.2 Transportation Requirement

The following conditions should be met for the transportation of BESS:

- Ensure that the door is locked.
- Select appropriate crane or lifting tool according to the site conditions. The lifting tool used shall have a sufficient load bearing capacity, boom length and radius of rotation.
- Additional traction may be required if ESS needs to be transported on slopes.
- Remove all obstacles that exist or may exist on the way, such as tree branches, cables, etc. The BESS should be transported and moved under good weather conditions.
- Be sure to set up warning signs or warning area to prevent non-staff from entering the lifting area to avoid accidents.
- When transporting by road, it is important to use ropes to secure the top ring of the equipment to the transport vehicle to avoid excessive tilt during transportation.

The battery products should be transported after packaging and during the transportation process, severe vibration, impact, or extrusion should be prevented to prevent sun and rain. It can be transported using vehicles such as cars, trains, and ships.

Always check all applicable local, national, and international regulations before transporting a Lithium Iron Phosphate battery.

Transporting an end-of-life, damaged, or recalled battery may, in certain cases, be specially limited or prohibited.

The transport of the Li-Ion battery falls under hazard class UN3480, class 9. For transport over water, air and land, the battery falls within packaging group PI965 Section I.

Use Class 9 Miscellaneous Dangerous Goods and UN Identification labels for transportation of lithium-ion batteries which are assigned Class 9. Refer to relevant transportation documents.



Class 9 Miscellaneous Dangerous Goods and UN Identification Label

3.3 Storage requirement

- During the rainy season to prevent possible condensation or its bottom being soaked by rain.
- BESS should be stored on higher ground. Raise container bases based on site conditions. The specific height should be reasonably determined according to the geological and meteorological conditions of the site.
- Stored on dry, flat, stable ground with sufficient carrying capacity and without any vegetation cover.
- The ground must be flat and dry. Before storage, ensure that BESS's door is locked.
- Storage ambient temperature:-30°C~60°C, recommended storage temperature: 25°C.



Notice! : To ensure battery life, keep the storage temperature of the battery module between 0 ° C and 35 ° C

Storage If the battery energy storage system is not used for a long time, please refer to the following table to save power. After charging is complete, turn off all switches of the battery energy storage system to ensure the lowest power consumption of the system.

The relative humidity should be between 0 and 95% without condensation.

The inlet and outlet of BESS should be effectively protected to prevent rain, sand and dust from penetrating into. Check equipment regularly for damage.

When the cabinet is stored at an ambient temperature below -15°C for a long time, it is necessary to take out the lead-acid battery and store it separately in an environment above -15°C.



4. Mechanical Installation

4.1 Inspection Before Installation

4.1.1 Deliverables Inspection

Check whether deliverables are complete against the packing list.

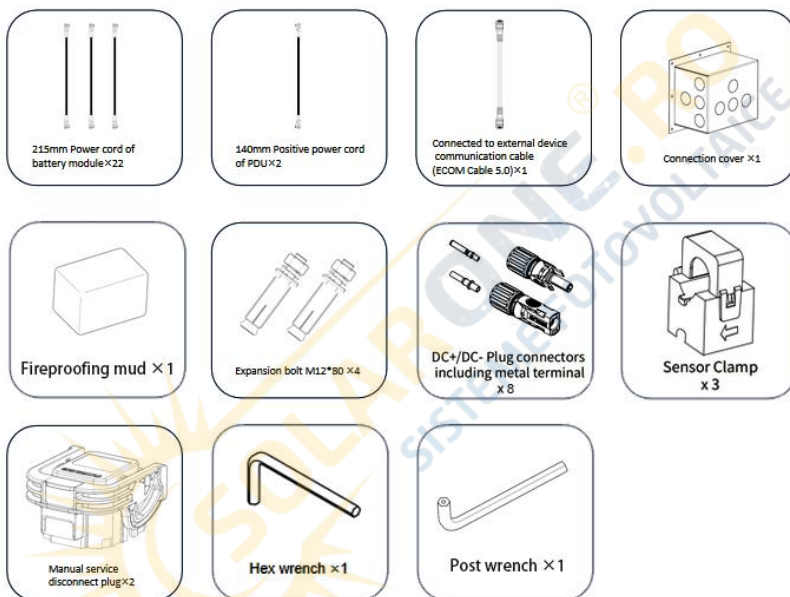

- Note: Dc+ plug connectors, including metal terminals and number of 8; Dc- plug connectors, including metal terminals and number of 8.
- Connection cover: for on-site wire connection and steel head installation.
- Fireproof mud: After the PV line and signal line are connected from the bottom of the distribution bin, the fireproof mud can be used to block the excess gap to prevent bugs from entering.
- Hex wrench: When the external line is connected to the circuit breaker of the distribution box, this wrench can be used to disassemble and install it.
- Post wrench: When the louvers of the distribution bin need to be repaired and replaced, this wrench can be used to remove and install screws.

Check BESS and internal equipment for damage. If you find any problems or have any questions, please contact the agency or Deye ESS.

4.2 Installation Environment

- The environment around the installation site should be dry and well-ventilated.
- The installation site should be far away from the concentration of toxic and harmful gases, and away from flammable, explosive and corrosive materials.
- The installation site should be far away from residential areas to avoid noise.

Installation site requirements

Unreasonably constructed foundation will bring great troubles to the installation of the BESS, affecting the normal opening and closing of the doors and the normal operation. Therefore, the foundation of the BESS must be designed and constructed according to certain standards to meet the requirements of mechanical support, cable routing and later maintenance and overhaul. **At least the following requirements shall be met during foundation construction:**

- The soil at the installation site should be compact.
- Compact and fill the foundation pit to provide sufficient and effective support for the cabinet.
- Raise the foundation to prevent the cabinet base and the interior from rain erosion.
- The cross-sectional area and height of the foundation should meet the requirements. It is recommended that the base height be greater than or equal to 300mm.
- Construct corresponding drainage in conjunction with local geological conditions.
- Build drainage systems according to local geological conditions.
- The foundation height is determined by the construction party according to the site geology.
- Consider cable routing when building the foundation.
- Built a maintenance platform around the foundation to facilitate later maintenance.
- During the foundation construction, reserve enough space for the AC/DC side cable trench according to the position and size of the cable inlet and outlet holes of the BESS and PCS, and pre-embed the cable conduit. Refer to the image below, left 1.
- Determine the specifications and quantity of the perforating gun according to the model and quantity of the cables.
- A drainage system is necessary to prevent the bottom or internal equipment of the BESS from being soaked in water during the rainy season or during heavy rainfall.
- Both ends of all embedded pipes should be temporarily sealed to prevent impurities from entering and causing troubles to later wiring.
- After all cables are connected, cable inlet and outlet and connector should be sealed with fireproof mud or other suitable materials to prevent rodent access.
- When installing the design base, you are advised to add protection to the PV cable at the bottom to prevent cable breakage.

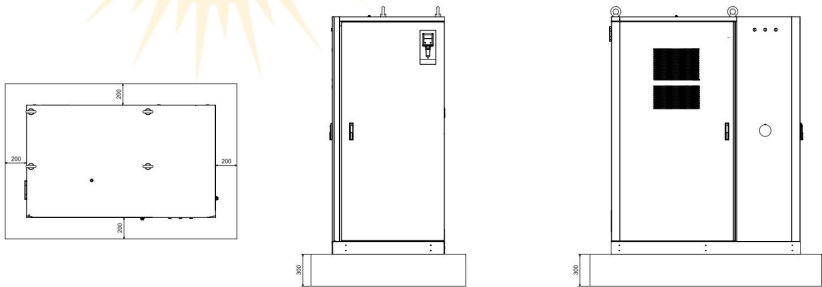

Foundation laying drawing (Unit: mm)



Notice! : The dregs excavated during the foundation construction should be removed immediately to avoid affecting the hoisting in the later stage.

The back of the cabinet has a blast release plate, and the back of the cabinet should be at least 800mm away from the wall when it is installed against the wall.



4.3 Installation Spacing Requirement

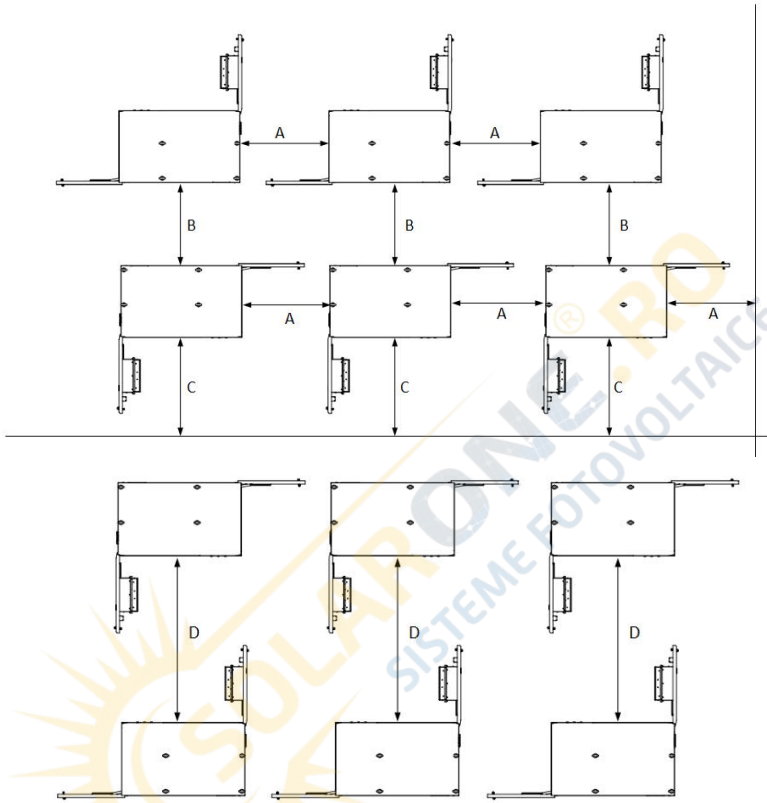

Installation spacing drawing (Unit: mm)

Serial number	Distance
A	1000
B	1600
C	1200
D	2400

4.4 Foundation requirements

An inadequately constructed foundation can introduce substantial challenges to the installation of Energy Storage Systems (ESS), affecting the smooth operation of doors and the overall functionality of the system. Consequently, the foundation for an ESS must be meticulously designed and constructed in accordance with established standards. This ensures it fulfills the necessary requirements for mechanical support, cable routing, and future maintenance and overhaul operations. During the construction of the foundation, at least the following criteria must be satisfied:

1. **Surface Material:** Install cabinets on concrete or other non-combustible surfaces.
2. **Surface Condition:** Ensure the surface is level, secure, flat, with sufficient load-bearing capacity, and free of depressions or tilts.
3. **Concrete Specifications:** Default to C30 grade concrete with a thickness of 200mm if not specified.
4. **Extension Beyond Cabinet:** Extend each side 300mm beyond the cabinet edges.
5. **Reinforcing Steel Bars:** Use HRB400 (Grade III) steel bars, 12mm diameter, spaced 150mm apart.
6. **Anti-Corrosion Measures:** Apply anti-corrosion treatments to steel bars after rust removal as per standards.
7. **Bedding Layer:** Use a 100mm thick C15 grade bedding layer under the slab.
8. **Bearing Stratum:** Foundation bearing stratum must be undisturbed soil with a characteristic bearing capacity $\geq 100\text{Kpa}$.
9. **Dewatering Measures:** Implement dewatering during construction to prevent waterlogging in the foundation pit.
10. **Excavation Safety:** Ensure proper safety measures for excavation support.
11. **Water Prevention:** After excavation, the foundation pit must not be soaked in water. If disturbed by water, further excavation and replacement filling are required.
12. **Height Requirement:** The foundation must be higher than the local historical highest water level and at least 300mm above the ground level.
13. **Drainage System:** Build drainage facilities according to local geology and municipal drainage requirements to ensure no water accumulation occurs at the equipment foundation. It should meet the drainage needs for the largest rainfall in local history. Discharged water from the drainage system must be treated in accordance with local laws and regulations.
14. **Surface Leveling:** The levelness error between the equipment foundation and the cabinet contact surface must be $\leq 3\text{mm}$.
15. **Pit Compaction:** The bottom of the equipment foundation pit must be compacted and leveled before proceeding with construction.
16. **Weight Bearing:** The equipment foundation is configured according to the total weight of the equipment. If the bearing capacity of the foundation does not meet requirements, re-verification is necessary.
17. **Cable Management:** When building the foundation, consider the cable outlet of the energy storage system and reserve trenches or inlet holes accordingly.
18. **Sealing:** Both the reserved holes of the equipment foundation and the inlet holes at the bottom of the equipment should be sealed after installation.

Cable Trench Requirements

For energy storage cabinets adopting the bottom cable entry method, a trench must be pre-installed on-site

since no side cable inlets are provided to prevent foreign objects from entering. The following requirements apply to the trenches:

1. **Dust-proof and Rodent-proof Design:** To avoid foreign objects entering the energy storage cabinets, the trench must have an effective dust-proof and rodent-proof design.
2. **Waterproof and Moisture-proof Measures:** In order to prevent cable aging and short circuits that could impact the normal operation of the energy storage cabinets, the trench needs waterproof and moisture-proof measures.
3. **Sufficient Cable Bending Radius:** Considering the larger power rating of the energy storage cabinets and the requirement for thicker cables, the trench design must take into account the cross-sectional area of the cables and provide a sufficient bending radius.



Warning!

The foundation drawing cannot be used as the final construction drawing but only for reference. Users must verify the design parameters of the energy storage system foundation based on the installation environment, ground bearing capacity, geological conditions, and seismic requirements of the project site.

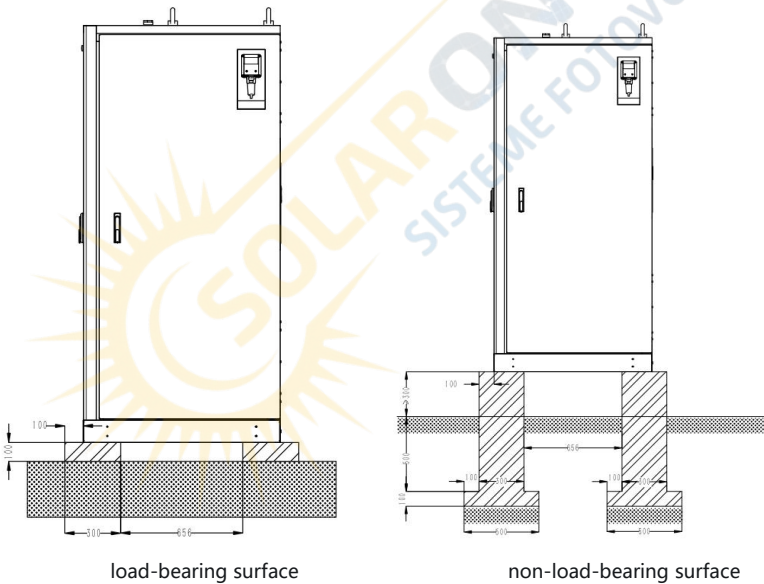

4.5 Transportation and lifting

4.5.1 Transportation

Forklift Transport If the installation site is flat, use a forklift to move the equipment. The bottom of the machine has a special forklift transport fork hole. A forklift with a rated load of more than 3000kg should be used.

Suggest to insert the forklift tooth in the location indicated below. The center of gravity is indicated in the diagram. Suggest to follow the safety precautions of forklift trucks.

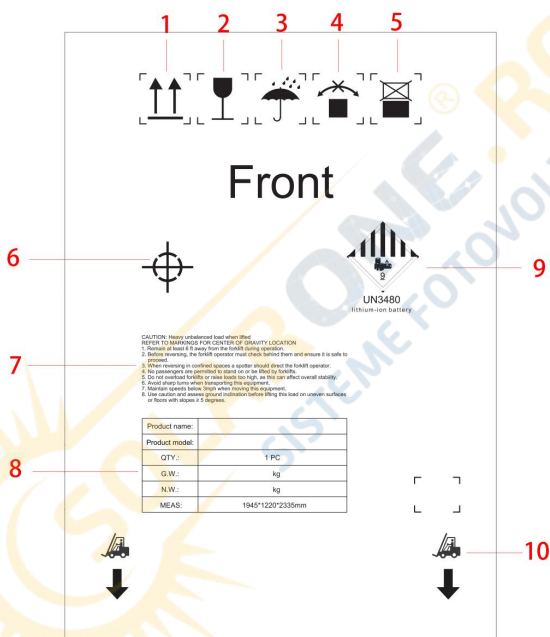

①	Wooden case should be placed face up
②	Fragile
③	Product should be stored against moisture
④	Prohibit to turn over product packaging during operation
⑤	Prohibit to stack
⑥	Center of gravity location
⑦	Forklift safety precautions
⑧	Product information
⑨	UN3480 Label
⑩	Forklift fork insertion position

If a forklift is used, the following requirements must be met: The forklift should be equipped with sufficient load capacity. The foot length of a forklift truck should meet the equipment requirements.

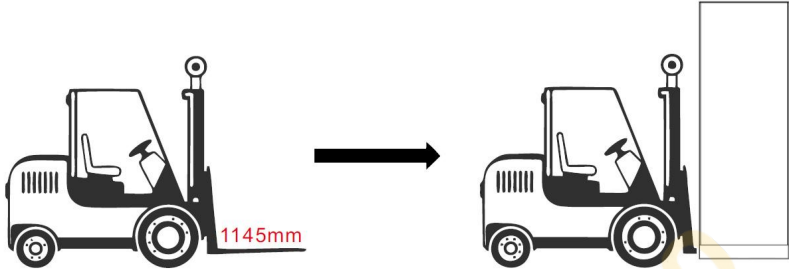

Caution! : Heavy unbalanced load when lifted
REFER TO MARKINGS FOR CENTER OF GRAVITY LOCATION



Notice!

- Remain at least 6 ft away from the forklift during operation.
- Before reversing, the forklift operator must check behind them and ensure it is safe to proceed.
- When reversing in confined spaces a spotter should direct the forklift operator.
- No passengers are permitted to stand on or be lifted by forklifts.
- Do not overload forklifts or raise loads too high, as this can affect overall stability.
- Avoid sharp turns when transporting this equipment.
- Maintain speeds below 3mph when moving this equipment.
- Use caution and assess ground inclination before lifting this load on uneven surfaces or floors with slopes ≥ 5 degrees.
- During transportation, avoid tilting the cabinet or placing it upside down. If the cabinet must be tilted or inverted during transportation, please straighten it as soon as possible, and the cabinet needs to be left standing for 2 hours before it can be powered on.
- During transportation, the built-in air conditioner can be transported separately from the cabinet to avoid damage to the performance of the air conditioner caused by tilt placement during transportation.

4.5.2 Hoisting Equipment



Warning! :

Comply with crane safety procedures at all times.

Do not stand within 500-1000mm of the lifting area! During the whole lifting process, no one is allowed to stand under the boom or the work station.

The lifting work must be stopped in bad weather. For example, in the case of strong winds, heavy rain or thick fog.

When hoisting, a 25-ton crane should be used, and the lifting arm is required to be about 38.5 meters to 40.5 meters.

When lifting the device, at least the following requirements must be met:

- All safety requirements must be met.
- A professional instructor is needed in the whole hoisting process.
- The strength of the sling used should be able to withstand the weight of the devices.
- Ensure that all sling connections are safe and reliable, and that the lengths of the slings connected to the corner fittings are equal.
- The length of the sling can be adjusted appropriately according to the actual requirements of the site.
- During the lifting process, the devices must be stable and not skewed.
- Please lift the devices from the bottom.
- Take all necessary auxiliary measures to ensure the safe and smooth lifting of the devices.

The following figure shows the crane operation during lifting the devices. In the figure, the dashed circle on the inner layer represents the crane operating range. When the crane is working, it is strictly forbidden to stand inside the solid circle on the red outer layer!

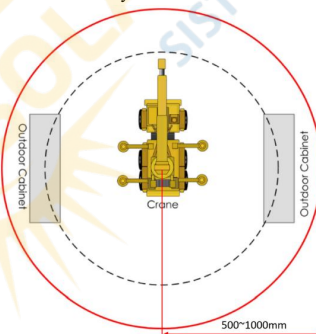

4.5.3 Hoisting

In the process of lifting the devices, each operation link should be carried out according to the following requirements:

- The equipment should be hoisted vertically and should not be dragged on any surface during hoisting.
- Check the connection between the lifting tool and the device before hoisting.
- Only lift it after confirming that the connection is secure. Once in place, the device should be gently and smoothly lowered. Do not place the device vertically and do not shake the lifting tools.
- The place where the devices are placed should be solid and flat, with good drainage, without obstacles or protrusions

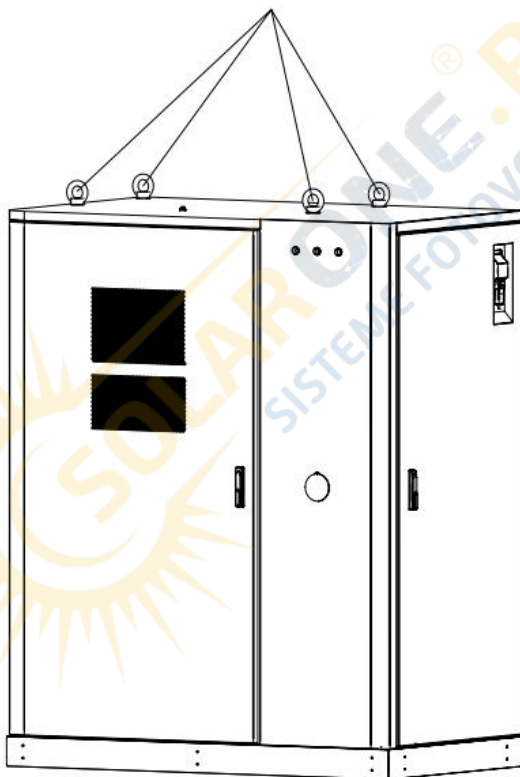

4.6 Fixing Methods

The following figure shows the positions secured by expansion screws at the bottom of the cabinet.

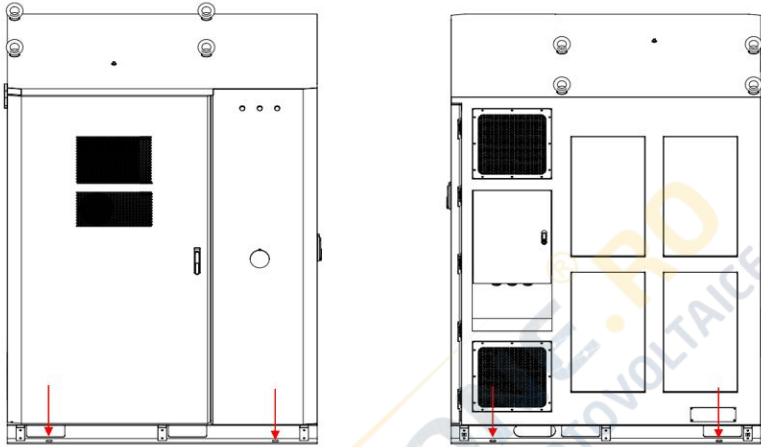

- First, use an electric hammer to drill holes on the floor according to the dimensions of the cabinet. The following figure shows the location dimensions of the expansion screw:

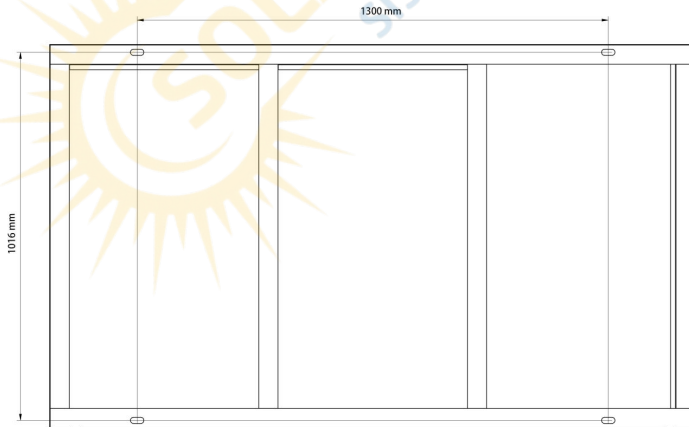

- Second, put the expansion screw into the drilled hole and remove the gasket and screw.

- Third, place the cabinet in the corresponding expansion screw holes, and add gaskets to tighten the nuts.
- Fourth, check the installation.



5. Electrical connection



Notice! : High voltage! Shock!

Do not contact live parts directly without protection!

Before installation, ensure that there is no voltage on the AC side and DC side.

Do not place the BESS on a flammable surface.



Warning!

Sand and moisture infiltration can damage the electrical equipment in the container or affect its operating performance! Do not perform electrical connections during sandstorms or when the relative humidity of the surrounding environment is greater than 95%. Make electrical connections when there is no wind or sand and when the weather is clear and dry.

Before connecting cables, check that the polarity of all input cables is correct. Do not pull wires and cables forcibly during electrical installation. Otherwise, the insulation performance may be affected. Make sure all cables and wires have enough room to bend. Take necessary auxiliary measures to reduce the stress on cables and wires. After each connection is complete, carefully check whether the connection is correct and secure.

5.1 Cabinet DC expander (System)

Battery Expansion (One GE-F120 is in parallel with four GE-F60s)



Battery Expansion (Six GE-F120 parallel machines)

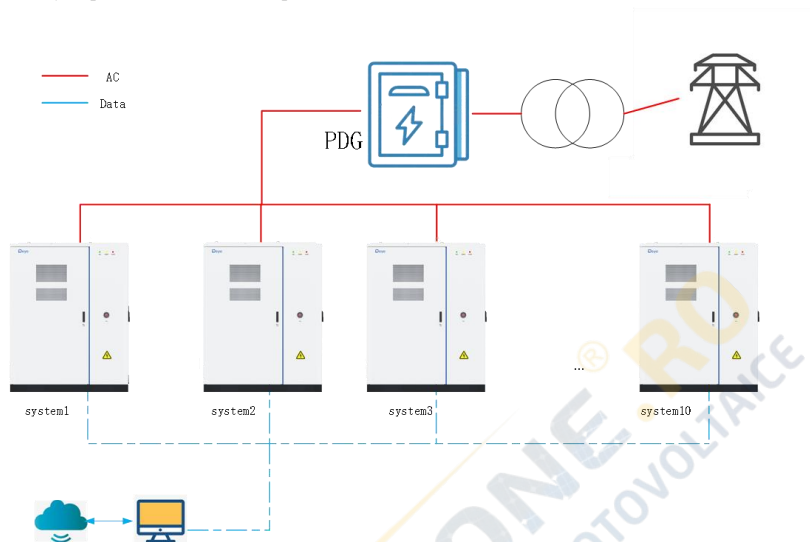

5.2 Electrical connection Overview



Warning!





All electrical connections must be made in strict accordance with the wiring schematic.

All electrical connections must be made when the equipment is completely powered off.

Only qualified electrical engineers can carry out work related to electrical connections. Please comply with the requirements in "1 Safety Precautions" of this manual. The Company shall not be liable for any injury or loss of life or property caused by ignoring these safety instructions.

5.3 Preparation before connection

Installation preparation tool

Item	Name and Graphics		
Installation tool	 Torque screwdriver	 Wire stripper	 Hydraulic pliers
	 Heat gun	 Multimeter	 Torque wrench
	 Electric hammer		
Protective tools	 Safety gloves	 Goggles	 Safety shoes
	 Protective clothing		

Opening mode

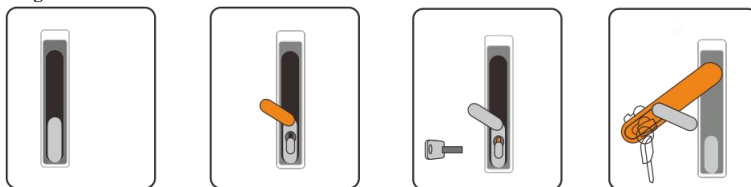

Opening procedure

1. Locked State
2. Move the cover above the keyhole upward
3. Insert the door key and turn it clockwise to eject the handle
4. Turn the handle clockwise to the position shown in the picture to open the front door.

5.4 Cables are connected to a single cabinet

5.4.1 Cable connections inside BESS

The internal battery pack power cable is connected in series.

Communication cable connection: **110mm communication cable for battery module** is used to connect the battery module to the battery module, and **200mm communication cable for PDU** is used to connect the battery module to the PDU. Note the directions of DI and DO on the communication line. Do not insert by mistake.

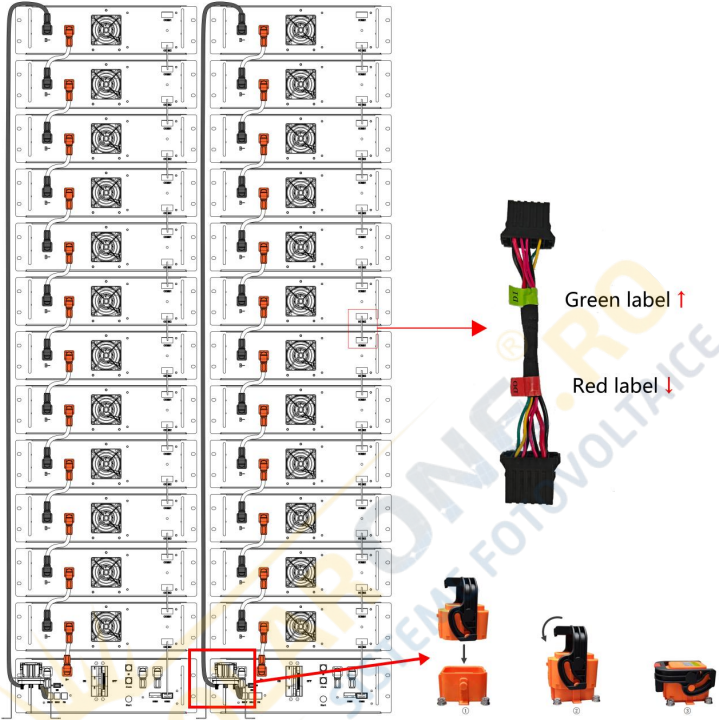

The green header connects to the comm2 port in the cabinet, and the red header connects to the comm1 port in the cabinet.
Please plug in the MSD after all power lines have been connected.

Danger!

Wrong connection mode: Please do not connect as follows!

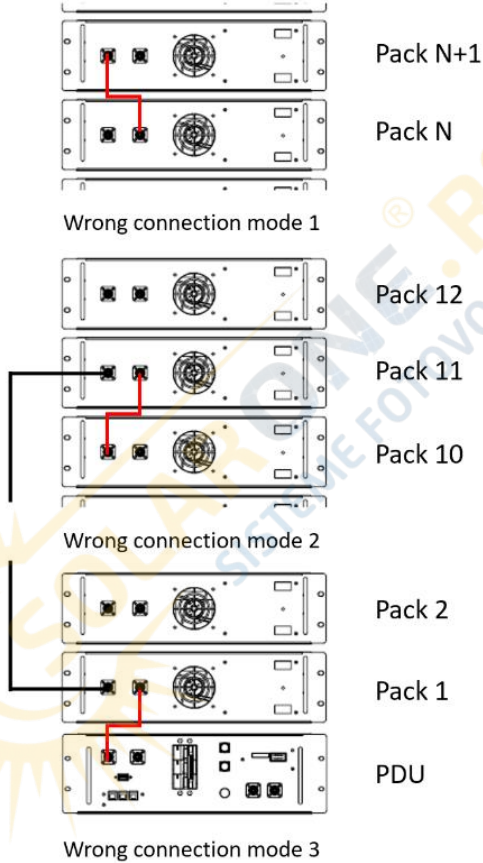

5.4.2 Ac power distribution cable connection

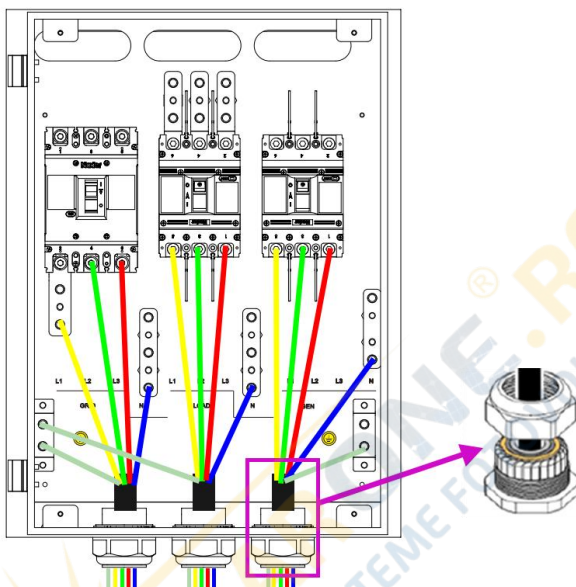

All wiring must be performed by a qualified personnel. It is very important for system safety and efficient operation to use appropriate cable for AC input connection. To reduce risk of injury, please use the proper recommended cable as below.

LOAD, GRID, GEN, N Cable connection requirements $\geq (35\text{mm}^2)$ cross section.

PE cable connection requirements $\geq (20\text{mm}^2)$ cross section.

Cable models are recommended for the AC power distribution box.

Line mark	Cross section (mm ²)	Crimp terminal model (OT terminal)
LOAD-L1、LOAD-L2、LOAD-L3	$\geq 35\text{mm}^2$	38-8
GRID-L1、GRID-L2、GRID-L3	$\geq 35\text{mm}^2$	38-8
GEN-L1、GEN-L2、GEN-L3	$\geq 35\text{mm}^2$	38-8
LOAD-PE GRID-PE GEN-PE	$\geq 20\text{mm}^2$	22-8

5.4.3 PV Module Wire connection

PV Connection

Before connecting to PV modules, please install a separately DC circuit breaker between inverter and PV modules. It is very important for system safety and efficient operation to use appropriate cable for PV module connection.



To avoid any malfunction, do not connect any PV modules with possible leakage current to the inverter. For example, grounded PV modules will cause leakage current to the inverter. When using PV modules, please ensure the PV+ & PV- of solar panel is not connected to the system ground bar.



It is requested to use PV junction box with surge protection. Otherwise, it will cause damage on inverter when lightning occurs on PV modules.

PV Module Selection:

When selecting proper PV modules, please be sure to consider below parameters:

- 1) Open circuit Voltage(Voc) of PV modules can not exceed max. PV array open circuit voltage of inverter.
- 2) Open circuit Voltage(Voc) of PV modules should be higher than min. Start voltage.
- 3) The PV modules used to connected to this inverter shall be Class A rating certified according to IEC 61730.

Inverter Model	Optional		Standard configuration
	30kW	40kW	50kW
PV Input Voltage	600V(180V-1000V)		
PV Array MPPT Voltage Range	150V-850V		
No.of MPPT Trackers	3	4	
No.of Strings per MPPT racker	2+2+2	2+2+2+2	

PV Module Wire Connection:

- 1) Switch the Grid Supply Main Switch(AC)OFF.
- 2) Switch the DC Isolator OFF.
- 3) Assemble PV input connector to the inverter.



When using PV modules, please ensure the PV+ & PV- of solar panel is not connected to the system ground bar.



Before connecting, please make sure the polarity of PV array matches the “DC+” and “DC-” symbols.



Before connecting inverter, please make sure the PV array open circuit voltage is within the 1000V of the inverter.



DC+ male connector



DC- female connector



Please use approved DC cable for PV system.

Cable type	Cross section (mm ²)	
	Range	Recommended value
Industry generic PV cable (model: PV1-F)	2.5-4	2.5(mm ²)

The steps to assemble the DC connectors are listed as follows:

- 1) Strip off the DC wire about 7mm, disassemble the connector cap nut .

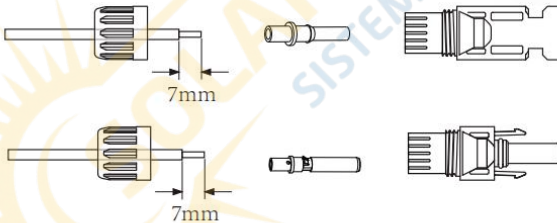

Disassemble the connector cap nut

- 2) Crimping metal terminals with crimping pliers.

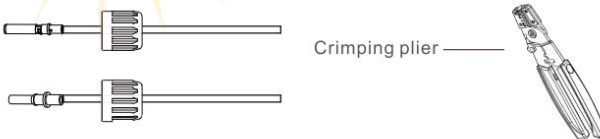

Crimp the contact pin to the wire

Insert the contact pin to the top part of the connector and screw up the cap nut the top part of the connector.(as shown in picture 5.5)

- 3) Insert the contact pin to the top part of the connector and screw up the cap nut to the top part of the connector.

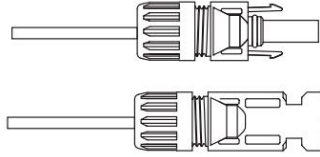

connector with cap nut screwed on

- 4) Finally insert the DC connector into the positive and negative input of the inverter.

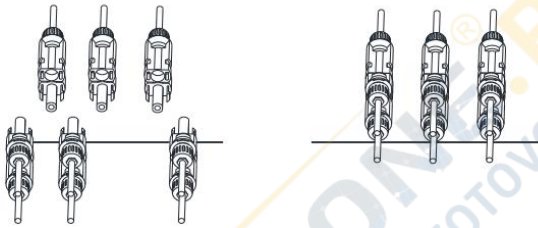

DC input connection



Sunlight shines on the panel will generate voltage, high voltage in series may cause danger to life. Therefore, before connecting the DC input line, the solar panel needs to be blocked by the opaque material and the DC switch should be 'OFF', otherwise, the high voltage of the voltage of the inverter may lead to life-threatening conditions. Please do not switch off DC isolator when the DC current when there is high voltage or current. Technicians need to wait until night to keep safety.



Please use its own DC power connector from the inverter accessories. Do not interconnect the connectors of different manufacturers. Max. DC input current should be 20A. if exceeds, it may damage the inverter and it is not covered by Deye warranty.

PV wiring description: PV

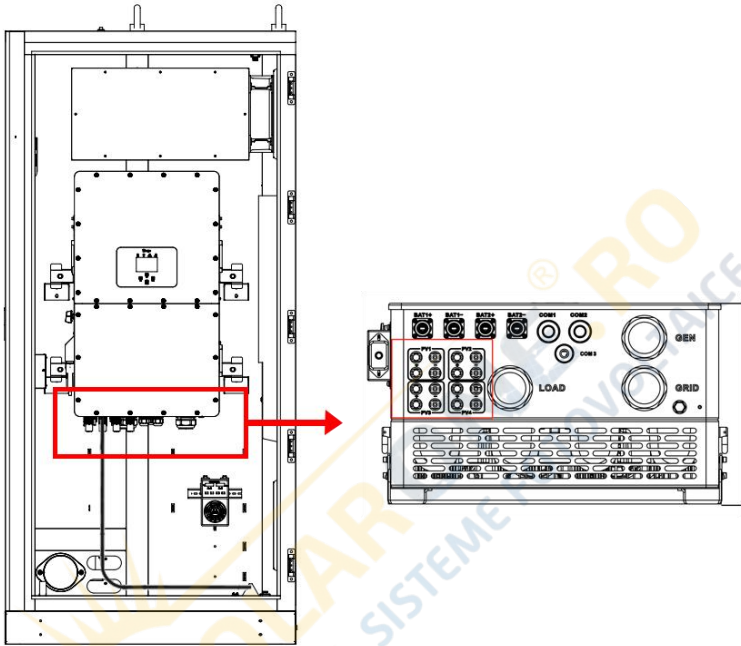

5.4.4 Topological schematic diagram

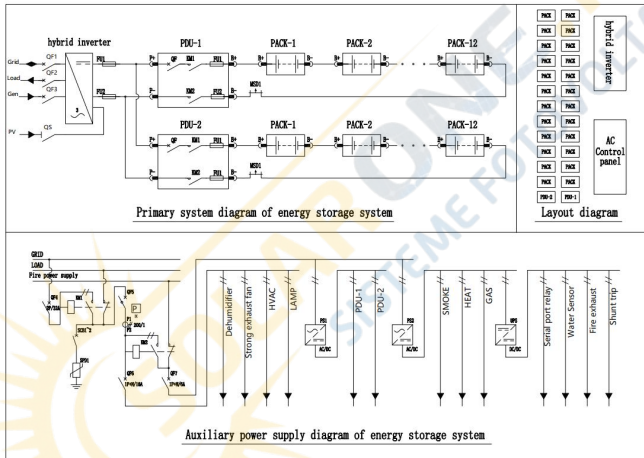

5.4.5 Power supply connection guide for backup power supply of fire alarm system

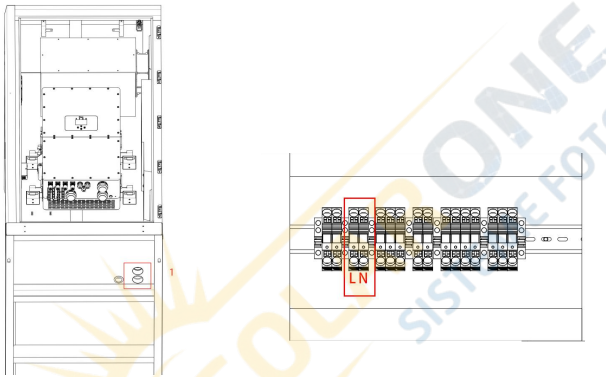

1. It is recommended that the client must connect the fire protection power supply (220V AC, 50 Hz), ensuring that the neutral wire and live wires are properly connected.
2. When wiring, it is recommended to thread cables through the bottom hole (1) and to use a cable with a cross-sectional area of 3.3 mm².
3. When connecting the fire protection circuit, it is essential to ensure that both L1 (live) and N (neutral) have protective loops installed.

5.4.6 GE-F120 and GE-F60 are connected in parallel

Note: To use cable cross section 22 mm²

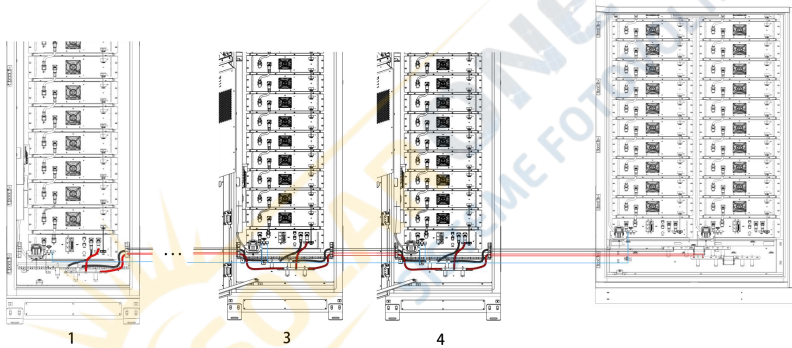

1. Combine 1 GE-F120 with 4 GE-F60 (can support 1-4 GE-60 and 1 GE-120 parallel).
2. When wiring, be sure to power off the wiring.
3. The blue line is the communication line, the red and black lines are the positive and negative battery.

5.4.7 GE-F120 and GE-F60 parallel auxiliary power supply wiring diagram

Note: Cable 12AWG(3.3 square) should be used for auxiliary connection.

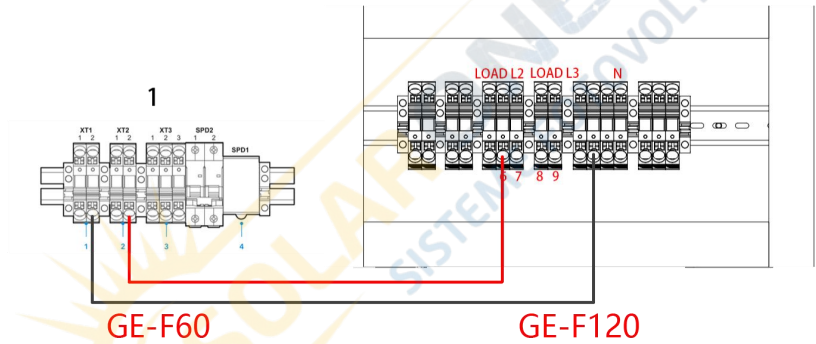

5.4.8 Auxiliary Wiring (GE-F120 connected to 2 GE-F60)

Note: 3.3 cable cross section (mm²) should be used for auxiliary connection.

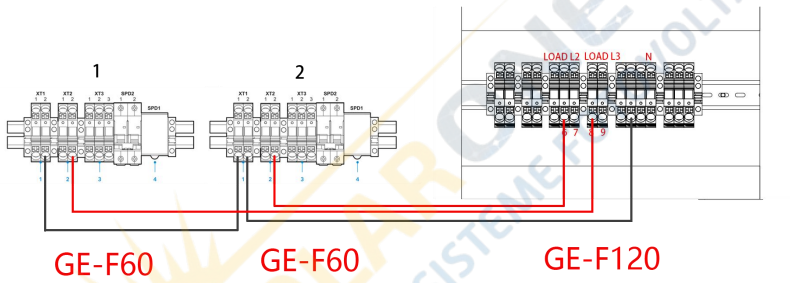

5.4.9 Auxiliary Wiring (GE-F120 connected to 3 GE-F60)

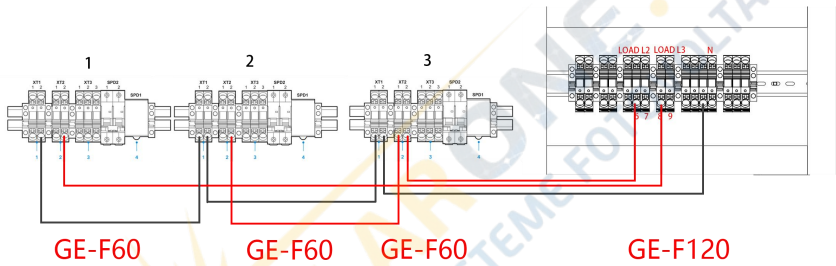

5.4.10 Auxiliary Cable (GE-F120 connected to 4 GEF60)

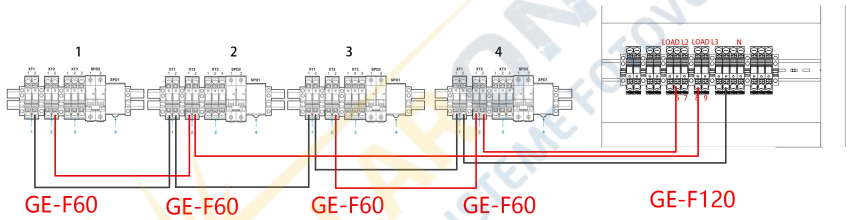

5.4.11 Description of communication cables connecting GE-F120 and GE-120 cabinets

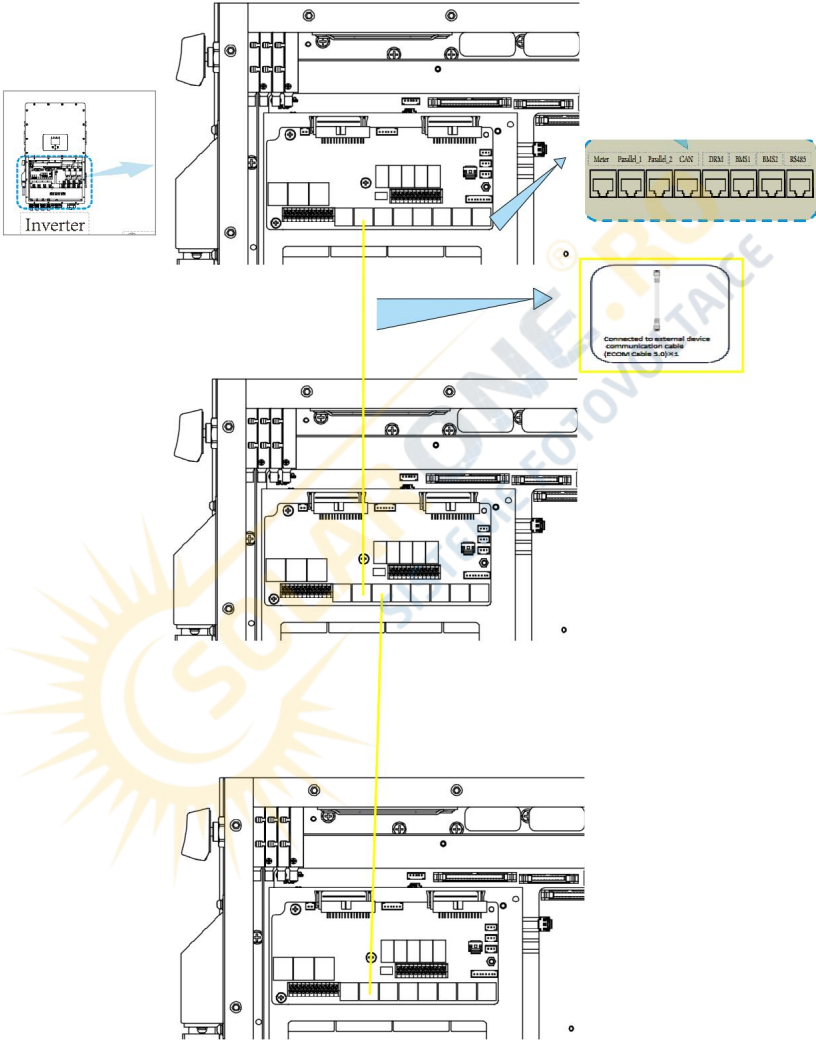

5.4.12 GE F120 and GE 120 combined AC power distribution cables are connected

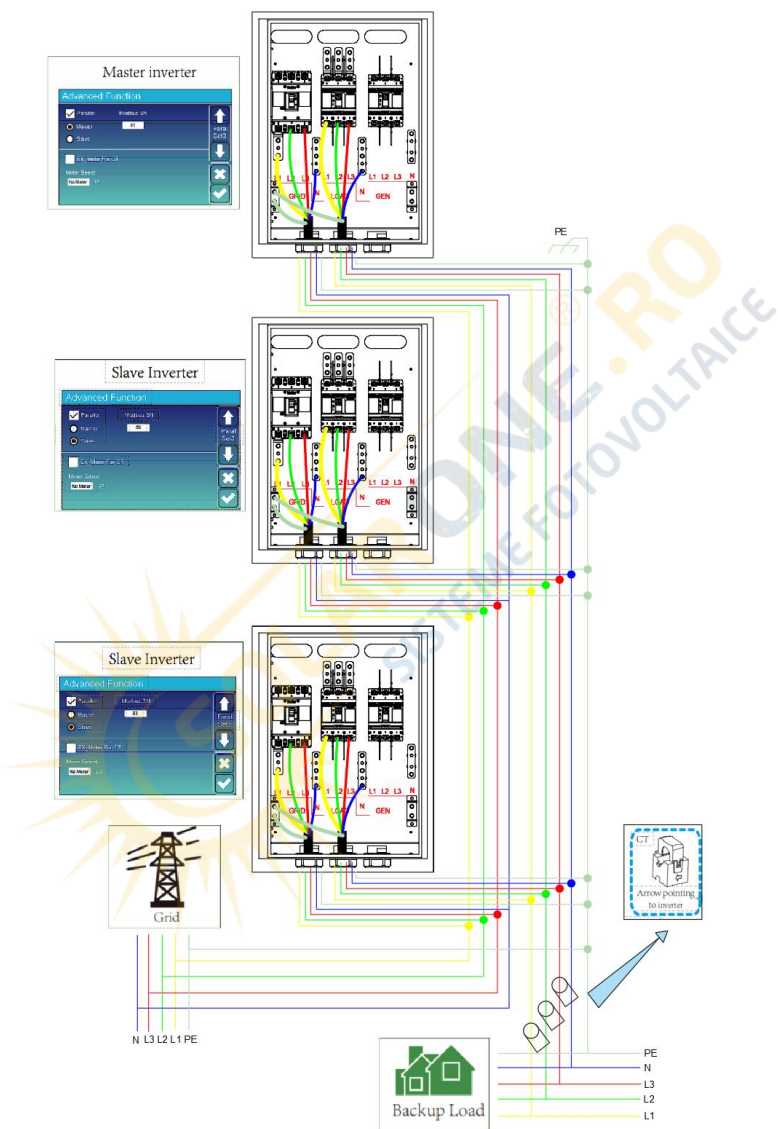

5.4.13 Wiring instructions for diesel power generation

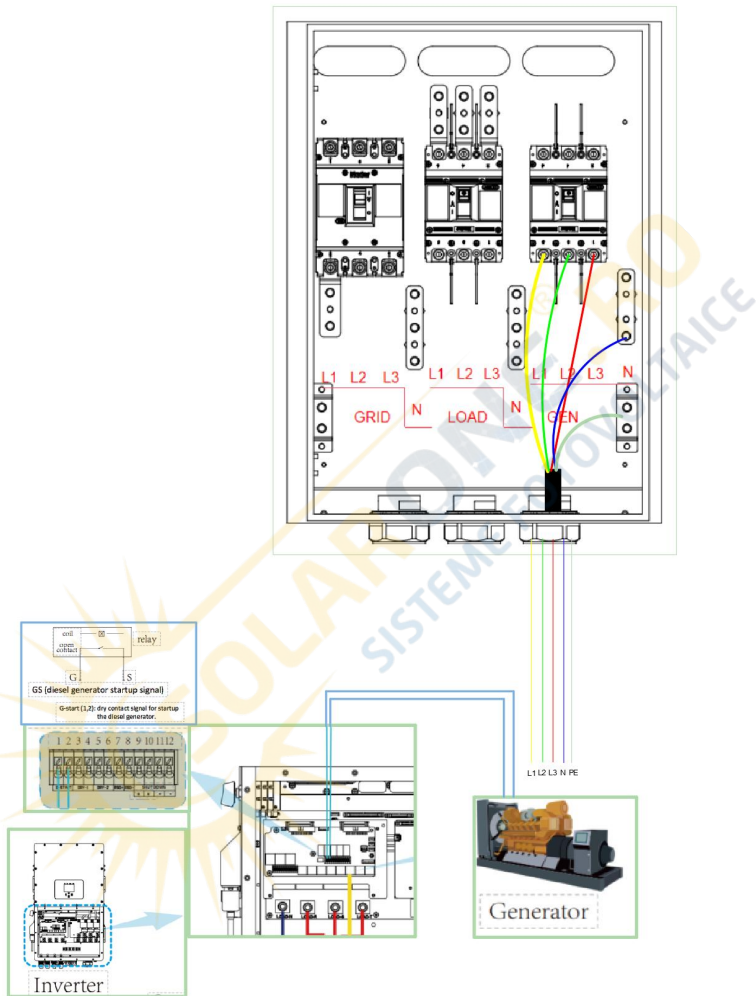

5.4.14 CT connection instructions

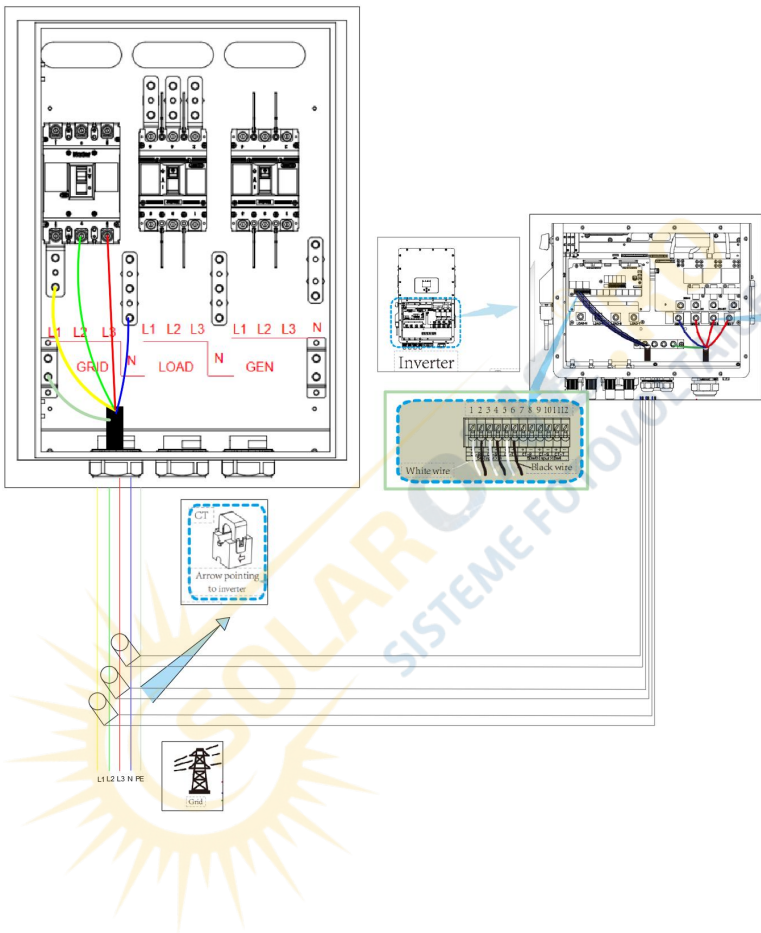

5.5 Operation after cable connection

When all electrical connections are complete, check the wiring thoroughly and carefully. In addition, you need to do the following:

- Check all air intakes and outlets for blockage.
 - Seal the gap around the cable inlet hole.
-



Warning!

- If improperly sealed, moisture may enter the product.
- If the product is not properly sealed, rodents may enter.

Lock the door operation

Procedure Step 1 Reinstall the cable protection cover in the reverse sequence.

Step 2 Lock the cabinet door, remove the key, and keep it secure.

— Take care to ensure that the seal around the cabinet door does not curl when the door is closed!

5.6 Battery Connection



Notice!

- When installing hazardous voltage equipment, comply with relevant regulations and local installation safety guidelines.
- Follow the rules for the proper use of tools and personal protective equipment.
- All connections must be made under clear guidance. Any attempt at speculation and ambiguity must be prohibited.
- Tools with an insulating protective coating must be used.

6. Activate BESS

Power on and off



Warning!

BESS needs to be confirmed by professionals and approved by the local power department before it can be put into operation.

For BESS with a long downtime, check the equipment thoroughly and carefully before powering on to ensure that all indicators are normal

Before powering on the device, check the following items:

- Check whether the wiring is correct.
- Check whether the emergency stop button is released.
- Check and confirm that there is no ground fault.
- Use a multimeter to check whether the AC voltage and DC voltage meet the starting conditions and ensure that there is no overvoltage.
- Check and make sure there are no left tools or parts inside the equipment.
- Check all air intakes and outlets for blockage.

6.1 Power-on procedure

After the cables are connected,

- ① Open the air switch of 2 high pressure boxes
- ② Open the start button on the two high pressure boxes
- ③ Turn on the QF4, QF5 and QF6 air switches in the power distribution area successively
- ④ open the PCS ON/OFF button
- ⑤ Turn on circuit breakers QF1, QF2 and QF3 successively

1	Air switch
2	START
3	QF4
4	QF5
5	QF6
6	PCS switch
7	QF1
8	QF2
9	QF3

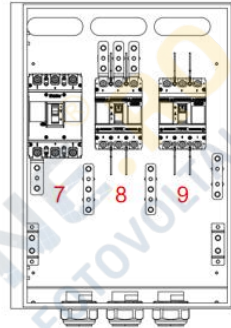
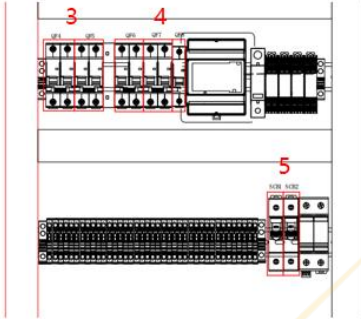
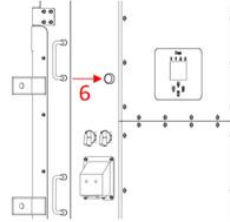
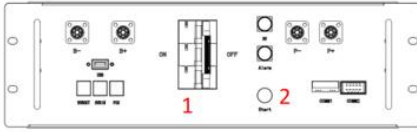

6.2 Power-off procedure

- ① Press the PCS ON/OFF button
- ② Disconnect QF1, QF2, and QF3 successively
- ③ Press the Start button of the high pressure box again
- ④ Finally, disconnect the air switch of the high pressure box

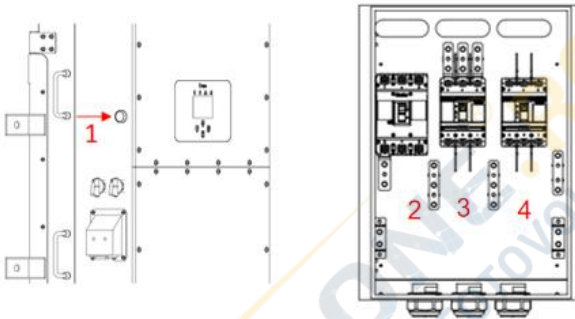
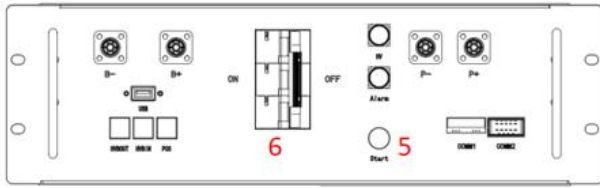

6.3 Unplanned (emergency) shut down

Fire incidents: Contact your local fire professional.

Unplanned downtime (downtime due to failure) : Contact Deye ESS.

7. Fire Suppression system

7.1 Fire flow chart

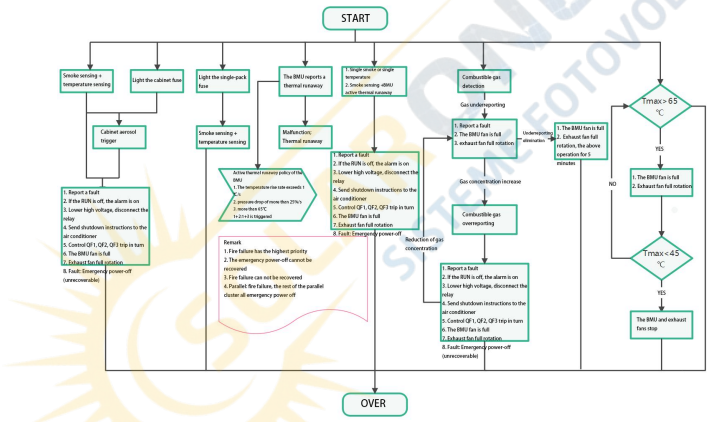

7.2 Fire Suppression equipment



Caution!

The battery is equipped with fire suppression equipment

General rules:

Please comply with the fire laws and regulations of the country/region where the project is located.

Regular inspection and maintenance of fire suppressing equipment to ensure its normal operation.

7.2.1 Aerosol fire suppression system

The battery is lithium iron phosphate battery, and the equipment is equipped with an aerosol fire suppression system. It is also equipped with smoke alarms and temperature alarms, and if anomalies are detected, the battery system will alarm and spray aerosols at the same time to stop the fire.

Notice: If the fire is too large, flee as soon as possible and call the fire police.

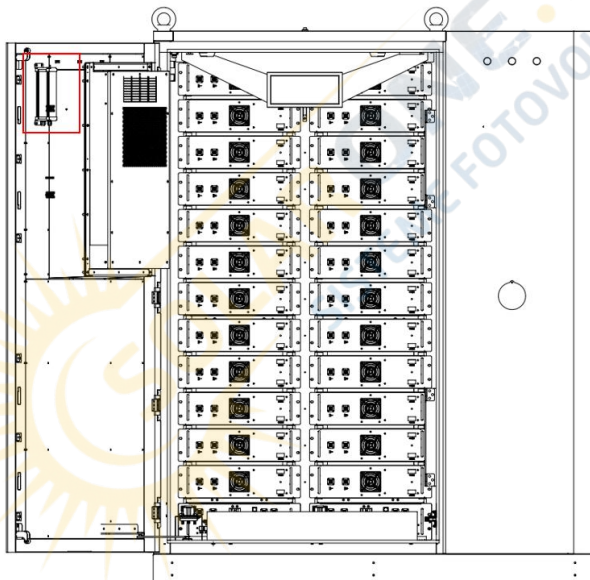

7.2.2 Fire suppression water pipe system

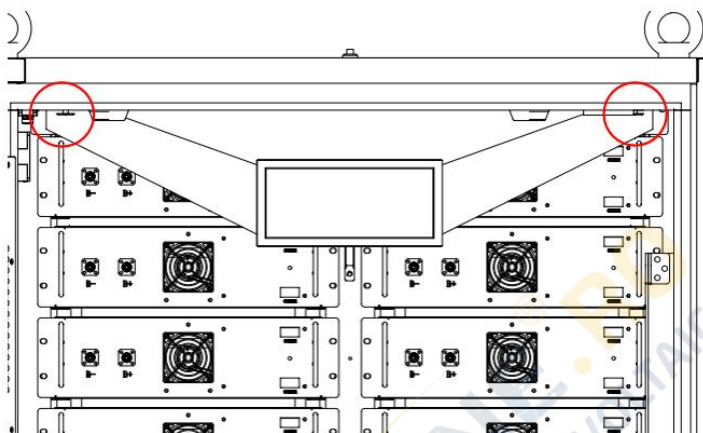

Notice! The temperature inside the BESS reaches 79 °C, and the yellow thermosensitive glass ball on the fire suppression water pipe explodes to spray water, fire suppression and cool the BESS



Notice! The recommended water pipe is DN32.

If the customer due to the site or construction difficulty and other reasons, you can choose not to install. If you choose to install a fire hose, the following are precautions for installing a fire hose.

Single cabinet installation

When installing a single cabinet, you are advised to install an extension pipe (the length is based on customer requirements). Then install an elbow water pipe, and connect with the water source to complete the water pipe installation (installation direction according to customer requirements).

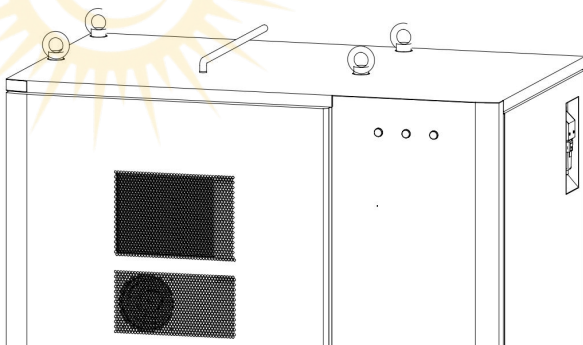

Multiple cabinet installation

When installing multiple cabinets, you are advised to install an extension pipe (the length is based on customer requirements). Then, install Tee-junction connectors, connect them to adjacent cabinets. Finally connect the water source (water source direction according to customer demand).

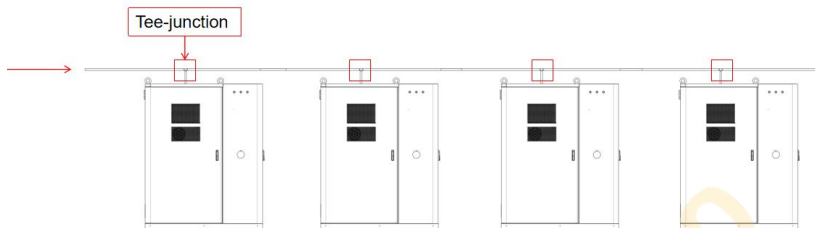

Optional: Customers can choose to keep the temperature bubble, no additional installation of water valve, by the temperature bubble control fire control. You can also choose to remove the temperature bubble by yourself, and connect the external water valve to achieve the control of fire flow.



Danger!: If the fire is too large, flee as soon as possible and call the fire police.



8. Troubleshooting

To determine the status of the battery system, users must use additional battery status monitoring software to examine the protection mode. Refer to the installation manual about using the monitoring software. Once the user knows the protection mode, refer to the following sections for solutions.

Fault Type	Fault Generation condition	Possible Causes	Troubleshooting
BMS fault	The cell voltage sampling circuit is faulty. The cell temperature sampling circuit is faulty	The welding point for cell voltage sampling is loose or disconnected. The voltage sampling terminal is disconnected. The fuse in the voltage sampling circuit is blown. The cell temperature sensor has failed.	Replace the battery.
Electrochemical cell fault	The voltage of the cell is low or unbalanced.	Due to large self- discharge, the cell over discharges to below 2.0V after long term storage. The cell is damaged by external factors, and short circuits, pinpricks, or crushing occur.	Replace the battery.
Overvoltage protection	The cell voltage is greater than 3.65 V in charging state. The battery voltage is greater than 58.4 V.	The busbar input voltage exceeds the normal value. Cells are not consistent. The capacity of some cells deteriorates too fast or the internal resistance of some cells is too high.	If the battery cannot be recovered due to protection against abnormality contact local engineers to rectify the fault.
Under voltage protection	The battery voltage is less than 40V. The minimum cell voltage is less than 2.5V	The mains power failure has lasted for a long time. Cells are not consistent. The capacity of some cells deteriorates too fast or the internal resistance of some cells is too high.	Same as above.
Charge or discharge high temperature protection	The maximum cell temperature is greater than 60°C	The battery ambient temperature is too high. There are abnormal heat sources around	Same as above.
Charge low temperature protection	The minimum cell temperature is less than 0°C	The battery ambient temperature is too low.	Same as above.
Discharge low temperature protection	The minimum cell temperature is less than -20°C	The battery ambient temperature is too low.	Same as above.

FAULT	Potential Fault Cause
OT (Over Temperature)	BMS negative connector overtemperature
	BMS positive connector overtemperature
	Pre-charge resistor overtemperature level-2 alarm
	Heating film overtemperature level-2 alarm
	Charge overtemperature level-2 alarm
	Discharge overtemperature level-2 alarm
UT (Under Temperature)	Charge under temperature level-2 alarm
	Discharge under temperature level-2 alarm
OC (Over Current)	Charge overcurrent level-2 alarm
	Discharge overcurrent level-2 alarm
DV (Differential Voltage)	Excessive differential voltage level-2 alarm
DT (Differential Temperature)	Excessive differential temperature level-2 alarm
OV (Over Voltage)	Total charge voltage too high
	Cell overvoltage level 2 alarm
UV (Under Voltage)	Charge voltage too low
	Total discharge voltage too low
	Cell undervoltage level-2 alarm
OF (Other Fault)	Abnormal numbers of BMU
	BMU lost
	RTC clock fault
	Current module fault
	SCHG total voltage acquisition fault
	Abnormal RS485 communication
	RS485 communication failure
	PCS-CAN BUS communication failure
	Repeated BMS address fault
	Repeated BMU address fault
	Abnormal power supply voltage

	Heating relay adhesion
	SOC too low
	SOC too high
	Fuse Blown
	Charge Relay Welded
	Discharge Relay Welded
	Master Positive Relay Welded
	Temperature Acquisition Failure
	Cell voltage acquisition fault
	Inter battery communication failure
	Pre-charge failure
	Insulation level 2 alarm
	External total voltage acquisition fault
	Internal total voltage acquisition fault
	Current acquisition fault
	Limit protection
	EEPROM failure
ISO	Insulation level 2

9. Hybrid Inverter Instructions

For information about inverter installation, please refer to the inverter installation manual. You can scan the following QR code to log in to the official website to obtain the inverter installation manual.



10. Inspection, cleaning and maintenance.

10.1 Basic Information

- The battery is not fully charged. It is recommended to complete the installation within 3 months after the arrival of goods.
- Do not disassemble any battery in the battery product, do not dissect the battery;
- After the battery is over-discharge, charge the battery within 48 hours. Battery products can also be charged in parallel. After the battery products are connected in parallel, the charger only needs to connect the output port of any product battery.
- Do not attempt to open or remove the battery! The battery contains no internal repairable parts.
- Before cleaning and maintaining the battery, disconnect all load and charging devices.
- When the ambient temperature exceeds 45 degrees, the product may reduce power.

10.2 Maintenance item and period

Maintenance of equipment

Every half a year to once a year

Item	Check method
Safety function	<ul style="list-style-type: none"> • Check whether the shutdown key on the touchscreen and the emergency stop button work normally. • Simulate shutdown.
Internal components inspection	<ul style="list-style-type: none"> • Check the temperature of the radiator and the amount of dust accumulated. Clean heat-dissipation modules with a vacuum cleaner if necessary. <p>Notice: It is necessary to check ventilation of the air inlet. Otherwise, fault may occur due to overheating if the module cannot be cooled effectively.</p>
Device maintenance	<ul style="list-style-type: none"> • Carry out regular inspection for corrosion of all metal components • Check the running parameters (especially voltage and insulation).

Maintenance (Once a year)

Item	Check method
Outside the BESS	<p>Check the following items, and correct immediately those failing to meet relevant requirements:</p> <ul style="list-style-type: none"> • Check whether there are flammable objects on the top of the BESS. • Check whether there is any damage, flaking paint or sign of oxidization on the enclosure. • Check whether the lock of the cabinet door can be unlocked flexibly. • Check whether the sealing strip is fixed properly.
Inside the BESS	Check whether there are foreign objects, dust, dirt, and condensed water inside the BESS.
Air inlet and outlet	Check the temperature of the radiator and the amount of dust accumulated. Clean heat-dissipation modules with a vacuum cleaner if necessary
Wiring and cable	Completely power off the devices inside the ESS before checking.

layout	<p>For any non-conformances found during inspection, correct them immediately.</p> <ul style="list-style-type: none"> • Check whether the cable layout is normal and whether there is a short circuit. For any non-conformances found during inspection, correct them immediately. • Check whether all cable entry is well sealed. • Check whether there is water seepage inside the BESS. • Check whether the power cables are loose, and fasten them again by the torque specified previously. • Check whether the power cables and control cables are damaged, especially if the surface contacting the metal surface is cut. • Check whether the insulation tapes on the power cable terminals fall off.
Ground connection and equipotential connection	<ul style="list-style-type: none"> • Check whether the ground connection is correct and the grounding resistance shall be no more than 0.4Ω. • Check whether the equipotential connection inside the integrated BESS is correct.
Screw	Check whether internal screws fall off.

Every two years

Item	Check method
System status and cleaning	<p>Check the following items, and correct immediately those failing to meet the relevant requirements:</p> <ul style="list-style-type: none"> • Check whether there is any damage or deformation of the container and internal devices. • Check if there is abnormal noise during operation of internal devices. • Check whether the temperature in the container is excessively high. • Check whether the humidity and the amount of dust inside the container are within the normal range. Clean the equipment if necessary. • Check whether the air inlet and outlet of the BESS are blocked.
Warning marks	Check whether the warning labels and marks are clearly visible and free of stains and damage. Replace them if necessary.
Surge protection device and fuse	Check whether the SPD and fuse are properly fastened.
Corrosion	Check whether there is oxidation or rust inside the container.

10.3 Battery Maintenance

Below is the recommended maintenance cycle. The actual maintenance cycle should be adjusted according to the specific installation environment of this product. In sandy or dusty environments, it is necessary to shorten the maintenance cycle and increase the frequency of maintenance.

Once every six months

Inspection item	Inspection method
Ambient temperature and humidity inspection	<ul style="list-style-type: none"> • Check whether the temperature in the ambient temperature record is within the operating range. • Check whether the humidity in the ambient humidity record is within the operating range.
Function inspection	<ul style="list-style-type: none"> • Check the operating status of the DC contactor: Send the Start/Stop command in the power-off status and check whether the system works properly. • Measure whether the output voltage is within the range in the specification. • Check whether the current, voltage and temperature in the operation record of the battery cluster are within the operating ranges.

Once a year

Inspection item	Inspection method
Switchgear and battery module	<p>Please check the following items and take corrective action immediately if you find any non-conformity:</p> <ul style="list-style-type: none"> • Check the top of the battery cluster for combustibles. • Check whether battery clusters are fixed on the baseplate and corroded. • Check the box for damage, peeling paint, oxidation, etc. • Check the battery cluster for foreign bodies, dust, dirt, and condensate.
Wire and cable layout	<ul style="list-style-type: none"> • The inspection must not be carried out until all internal devices of the battery cluster are powered off! In case of nonconformity found in inspection, take corrective actions immediately: • Check the cable layout for short circuit and compliance with the specifications. If case of any abnormality, take corrective actions immediately. • Check whether all wire inlets and outlets of the battery cluster are sealed properly. • Check the battery cluster for internal seepage of water. • Check whether the power cables and copper busbars are loose, and tighten them according to the aforesaid torque. • Check the power cable and communication cable for damage, especially cut marks on the surface exposed to the metal surface.
Grounding	Check whether the grounding is correct. The grounding resistance should not be greater than 4Ω.
Fan	<ul style="list-style-type: none"> • Check the fan for faults (e. g. locked rotor and stalling). • Check the fan for abnormal noise during operation.
Screw	Check whether screws inside the battery cluster fall off or are rusted.

once every two years

Inspection item	Inspection method
Battery cluster status and cleanliness	<p>Check the following items. In case of nonconformity, take corrective actions immediately:</p> <ul style="list-style-type: none"> • Check the battery cluster and internal devices for damage or deformation. • Check the internal devices for abnormal noise during operation. • Check whether the temperature inside the battery cluster is too high. • Check whether the internal humidity and dust of the battery cluster are within the normal ranges. If necessary, clean the battery cluster. • Check whether the air inlet and outlet of the battery cluster are blocked.
Warning sign	Check whether the warning sign and label are legible and dirty. If necessary, replace them.
Wire and cable	Check whether the switch gear and battery module are connected correctly and whether the battery modules are also connected correctly.
Corrosion	Check the battery cluster for internal oxidation or rust.

To maintain the system safely and efficiently, maintenance personnel must carefully read and comply with the following safety requirements:

1. Hold the electrician certificate issued by the Safety Supervision Bureau, and take up the post after professional training.
2. Follow safety precautions, use necessary tools, and wear personal protective equipment.
3. Do not wear jewelry, watches and other metal jewelry.
4. Under no circumstances, do not touch the high pressure positive and negative poles of the energy storage system with both hands.
5. Before maintaining the energy storage system, turn off all high-voltage and low-voltage switches.
6. Do not wash the product directly with water. Use a vacuum cleaner if necessary.
7. Cables should be inserted and removed in accordance with regulations. Violent or brute force operations are prohibited.
8. After the maintenance is complete, clean the tools and materials in time, and check whether metal objects remain inside or on the top of the product.
9. If you have any questions about the operation and maintenance of this product, please contact Deye ESS customer Service center, do not operate without authorization.

Instructions regarding maintenance of batteries:

-Servicing of batteries should be performed or supervised by personnel knowledgeable about batteries and the required precautions.

-When replacing batteries, replace with the same type and number of batteries or battery packs.

- General instructions regarding removal and installation of batteries.

- CAUTION: Do not dispose of batteries in a fire. The batteries may explode.

- CAUTION: Do not open or damage batteries. Released electrolyte is harmful to the skin and eyes. It may be toxic.

- CAUTION: A battery can present a risk of electrical shock and high short-circuit current. The following precautions should be observed when working on batteries:

- a) Remove watches, rings, or other metal objects.
- b) Use tools with insulated handles.
- c) Wear rubber gloves and boots.

- d) Do not lay tools or metal parts on top of batteries.
- e) Disconnect charging source prior to connecting or disconnecting battery terminals.
- f) Determine if battery is inadvertently grounded. If inadvertently grounded, remove source from ground. Contact with any part of a grounded battery can result in electrical shock. The likelihood of such shock can be reduced if such grounds are removed during installation and maintenance (applicable to equipment and remote battery supplies not having a grounded supply circuit).



11. Battery recycling

When the equipment or internal equipment reaches the end of its service life, it cannot be disposed of together with domestic waste. Some internal components can be recycled, and some components will cause environmental pollution.

11.1 Recovery process and steps of cathode materials

Aluminum foil as collector is amphoteric metal. Firstly, it is dissolved in NaOH alkali solution to make aluminum enter the solution in the form of NaAlO_2 . After filtration, the filtrate is neutralized with sulfuric acid solution and precipitated to obtain $\text{Al}(\text{OH})_3$. When the pH value is above 9.0, most of the aluminum precipitates, and the obtained $\text{Al}(\text{OH})_3$ can reach the level of chemical purity after analysis.

The filter residue is dissolved with sulfuric acid and hydrogen peroxide, so that lithium iron phosphate enters the solution in the form of $\text{Fe}_2(\text{SO}_4)_3$ and Li_2SO_4 , and is separated from carbon black and carbon coated on the surface of lithium iron phosphate. After filtration and separation, the pH value of the filtrate is adjusted with NaOH and ammonia water. First, iron is precipitated with $\text{Fe}(\text{OH})_3$, and the remaining solution is precipitated with saturated Na_2CO_3 solution at 90 °C.

Since FePO_4 is slightly dissolved in nitric acid, the filter residue is dissolved with nitric acid and hydrogen peroxide, which directly precipitates FePO_4 , separates impurities such as carbon black from acid solution, leaches $\text{Fe}(\text{OH})_3$ from filter residue respectively, and precipitates Li_2CO_3 with saturated Na_2CO_3 solution at 90 °C.

11.2 Recovery of anode materials

The recovery process of anode materials is relatively simple. After the separation of anode plates, the purity of copper can be more than 99%, which can be used for further refining electrolytic copper.

11.3 List of recycling equipment

Recovery of diaphragm

The diaphragm material is mainly harmless, and has no recycling value.

List of recycling equipment

Automatic dismantling machine, pulverizes, wet gold pool, etc.

12. Appendix

12.1 System Parameter

Model	GE-F120-2H2
System Specification	
Nominal Output Power/UPS Power (W)	50000
AC Output Frequency and Voltage	50/60Hz; 220/380, 230/400Vac
Grid Type	3L/N/PE
Number of Parallel (Off-grid)	10
Energy Configuration (kWh)	122.8
Dimension (W x D x H,mm)	1780×1056×2235
Weight Appr. (kg)	2090
AC Output Rated Current (A)	75.8
Battery Operating Voltage (V)	500~700
Max. RTE	89%
Battery Chemistry	LiFePO ₄
IP Rating of Enclosure	IP55
Installation Style	Floor-Mounted
Storage Temperature(°C)	-20~45(>45 derating)
Warranty	10 years
Inverter Technical Specification	
Max. PV Input Power(W)	65000
Max. PV Input Current(A)	36+36+36+36
Rated PV Input Voltage(Vdc)	600
Start Up DC Voltage (Vdc)	180
MPPT Voltage Range(Vdc)	150-850
Max. PV Short-circuit Current(A)	55+55+55+55
Number of MPPT	4
Peak Power(off grid)	1.5 time of rated power, 10s
Power Factor	0.8 leading to 0.8 lagging
THD	<3%
DC Injection current(mA)	<0.5%In
Display	LCD
Operating Temperature Range(°C)	-40~60C(>45 derating)
Relative Humidity	15%~85%(No Condensing)

Dimension(W x D x H,mm)	527×294×894
Inverter Communication	CAN, RS485, WIFI, ETH
Grid Regulation	VDE4105,IEC61727/62116,VDE0126,AS4777.2,CEI 0 21,EN50549-1, G98,G99,C10-11,UNE217002,NBR16149/NBR16150
Max. Efficiency	97.6%
MPPT Efficiency	99.9%
Battery Technical Specification	
Battery Module Nominal Voltage (V)	51.2
Battery Module Energy (kWh)	5.12
BMS Communication	CAN
Battery Module Dimension(W x D x H,mm)	440×570×133
Battery Module Weight (kg)	44
Operating Temperature Range	Charge: 0~55/Discharge: -20~55
Cycle Life	≥6000(@25°C±2°C,0.5C/0.5C,70%EOL)
Battery Module Certification	UN38.3, IEC62619, IEC61000

12.2 Contact Information

For more information on battery module handling, please contact us. Service hotline :+86 0574 8612 0560, Email :service-ess@deye.com.cn For more information, visit <http://deyeess.com>.

Comply with the regulations on waste battery disposal. Stop using the damaged battery immediately. Contact your installer or sales partner before processing. Keep the battery away from moisture or direct sunlight.